

**OWNER'S/  
OPERATOR'S  
MANUAL**

**MODEL NO.'s**

**UBH-2072**

**SSBH-2072**

**GLBH-2072**

**UBH-2072R**

**SSBH-2072R**

**JDBH-2072R**

**GLBH-2072R**

**⚠ CAUTION**

For Safe Operation  
Read Rules And  
Instructions Carefully

SI NO LEEINGLES, PIDA AYUDA  
A AIGUIEN QUE SI LO LEA  
PARA QUE LE TRADUZCA LAS  
MEDIDAS DE SEGURIDAD.

**BALE HAND**

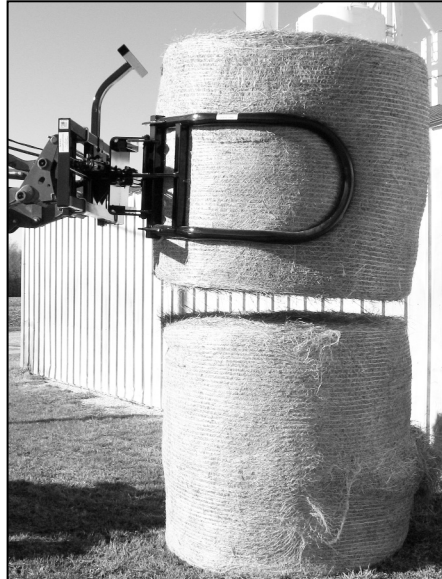
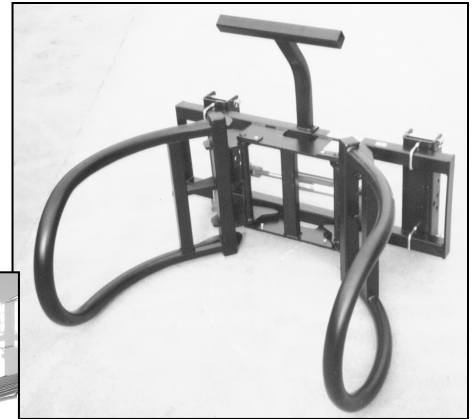

**ROTATING  
BALE HAND**

# **BALE HAND & ROTATING BALE HAND**

**Safety Instructions  
Tractor Preparation  
Operating Instructions**

**Assembly & Mounting  
Maintenance  
Repair Parts**

## **⚠ CAUTION**

**THE FOLLOWING SAFETY PRECAUTIONS SHOULD BE THOROUGHLY UNDERSTOOD  
BEFORE ATTEMPTING TO BEGIN ASSEMBLING THIS MACHINE**

1. Select an area for assembly that is clean and free of any debris which might cause persons working on the assembly to trip.
2. Do not lift heavy parts or assemblies. Use crane, jack, tackle, fork trucks or other mechanical devices.
3. Preview the assembly instructions in your operator's manual before proceeding further.
4. If the assembly instructions call for parts or assemblies to be blocked up, use only blocking material that is in good condition and is capable of handling the weight of the assembly to be blocked. Also insure that the blocking material is on a clean, dry surface.
5. Never put hands, or any part of body, under blocked up assemblies if at all possible.
6. After completing assembly, thoroughly inspect the machine to be sure that all nuts, bolts, hydraulic fittings or any other fastened assemblies have been thoroughly tightened.
7. Before operating the machine, thoroughly read the operation section of your operator's manual.
8. Before operating, read the maintenance section of your operator's manual to be sure that any parts requiring lubrication, such as gearboxes, are full, to avoid any possible damage.
9. **Before operating equipment – If you have any questions regarding the proper assembly or operation, contact your dealer or representative.**

# TABLE OF CONTENTS

WARRANTY .....	2
SAFETY INFORMATION .....	3-10
SAFETY SIGNS .....	10-11
PREPARATION INSTRUCTIONS .....	12-17
OPERATING INSTRUCTIONS .....	17-20
OWNER MAINTENANCE & LUBRICATION .....	20
TROUBLESHOOTING .....	21-22
PARTS LISTS .....	23-29

SI NO LEEINGLES, PIDA AYUDA A AIGUIEN QUE SI LO LEA PARA QUE LE TRADUZCA LAS MEDIDAS DE SEGURIDAD.

## STATEMENT OF POLICY

It is the policy of Worksaver, Inc. to improve its products where it is possible and practical to do so. Worksaver, Inc. reserves the right to make changes or improvements in design and construction at any time, without incurring the obligation to make these changes on previously manufactured units.

## TO THE OWNER:

Read this manual before using your Bale Hand. This manual is provided to give you the necessary operating and maintenance instructions for keeping your Bale Hand in top operating condition. Please read this manual thoroughly. Understand what each control is for and how to use it. Observe all safety signs on the machine and noted throughout the manual for safe operation of implement. Keep this manual handy for ready reference.

Like all mechanical products, it will require cleaning and upkeep. Lubricate the Bale Hand as specified.

Use only genuine Worksaver, Inc. service parts. Substitute parts will void the warranty and may not meet standards required for safe and satisfactory operation. Record the model and serial number of your Bale Hand here:

Model: \_\_\_\_\_ Serial Number: \_\_\_\_\_

## RETAIL CUSTOMER'S RESPONSIBILITY

**It is the Retail Customer and/or Operator's responsibility to read the Operator's Manual, to operate, lubricate, maintain, and store the product in accordance with all instructions and safety procedures. Failure of the operator to read the Operator's Manual is a misuse of this equipment.**

**It is the Retail Customer and/or Operator's responsibility to inspect the product and to have any part(s) repaired or replaced when continued operation would cause damage or excessive wear to other parts or cause a safety hazard.**

**It is the Retail Customer's responsibility to deliver the product to the authorized Worksaver Dealer, from whom he purchased it, for service or replacement of defective parts which are covered by warranty. Repairs to be submitted for warranty consideration must be made within forty-five (45) days of failure.**

**It is the Retail Customer's responsibility for any cost incurred by the Dealer for traveling to or hauling of the product for the purpose of performing a warranty obligation or inspection.**

# **LIMITED WARRANTY**

Worksaver warrants to the original purchaser of any new Bale Hand (Models UBH-2072, SSBH-2072, GLBH-2072, SSBH-2072R, UBH-2072R, JDBH-2072R and GLBH-2072R), that the equipment be free from defects in material and workmanship for a period of twelve (12) months for non-commercial, state, and municipalities. Use sixty (60) days for commercial use from date of retail sale.

Replacement or repair parts installed in the equipment covered by this warranty are warranted for sixty (60) days from the date of purchase of such part or to the expiration of the applicable new equipment warranty period, whichever occurs later.

Such parts shall be provided at no cost to the user during regular working hours. Worksaver reserves the right to inspect any equipment or parts which are claimed to have been defective in material or workmanship.

## **DISCLAIMER OF IMPLIED WARRANTIES & CONSEQUENTIAL DAMAGES**

Worksaver's obligation under this warranty, to the extent allowed by law, is in lieu of all warranties, implied or expressed, including implied warranties of merchantability and fitness for a particular purpose and any liability for incidental and consequential damages with respect to the sale or use of the items warranted. Such incidental and consequential damages shall include but not be limited to: transportation charges other than normal freight charges; cost of installation other than cost approved by Worksaver; duty; taxes; charges for normal service or adjustments; loss of crops or any other loss of income; rental of substitute equipment, expenses due to loss, damage, detention or delay in the delivery of equipment or parts resulting from acts beyond the control of Worksaver.

## **THIS WARRANTY SHALL NOT APPLY:**

1. To vendor items which carry their own warranties, such as hydraulic cylinders, tires, and tubes.
2. If the unit has been subjected to misapplication, abuse, misuse, negligence, fire or other accident.
3. If parts not made or supplied by Worksaver have been used in connection with the unit, if, in sole judgement of Worksaver such use affects its performance, stability, or reliability.
4. If the unit has been altered or repaired outside of an authorized Worksaver dealership in a manner which, in the sole judgement of Worksaver affects its performance, stability or reliability.
5. To normal maintenance service and normal replacement items such as bent forks, hydraulic fluid, worn blades, or to normal deterioration of such things as belts and exterior finish, due to use or exposure.
6. To expendable or wear items such as teeth, chains, sprockets, latch parts, springs and other items that in the company's sole judgement is a wear item.

NO EMPLOYEE OR REPRESENTATIVE OF WORKSAVER IS AUTHORIZED TO CHANGE THIS WARRANTY IN ANY WAY OR GRANT ANY OTHER WARRANTY UNLESS SUCH CHANGE IS MADE IN WRITING AND SIGNED BY WORKSAVER'S SERVICE MANAGER, POST OFFICE BOX 100, LITCHFIELD, ILLINOIS 62056-0100.

# To the Owner/Operator/Dealer

All implements with moving parts are potentially hazardous. There is no substitute for a cautious, safe-minded operator who recognizes the potential hazards and follows reasonable safety practices. The manufacturer has designed this implement to be used with all its safety equipment properly attached to minimize the chance of accidents.

## BEFORE YOU START!!

Read the safety messages on the implement and shown in your manual.  
Observe the rules of safety and common sense!





THIS SYMBOL MEANS

- ATTENTION!
- BECOME ALERT!
- YOUR SAFETY IS INVOLVED!

THIS SAFETY ALERT SYMBOL IDENTIFIES IMPORTANT SAFETY WARNING MESSAGES. CAREFULLY READ EACH WARNING MESSAGE THAT FOLLOWS. FAILURE TO UNDERSTAND AND OBEY A SAFETY WARNING, OR RECOGNIZE A SAFETY HAZARD, COULD RESULT IN AN INJURY OR DEATH TO YOU OR OTHERS AROUND YOU. THE OPERATOR IS ULTIMATELY RESPONSIBLE FOR THE SAFETY OF HIMSELF, AS WELL AS OTHERS, IN THE OPERATING AREA OF THE POWER UNIT AND ATTACHED EQUIPMENT.

---

## UNDERSTAND SIGNAL WORDS

- |                                                                                    |                |                                                                                                                                                                         |
|------------------------------------------------------------------------------------|----------------|-------------------------------------------------------------------------------------------------------------------------------------------------------------------------|
|   | <b>DANGER</b>  | Indicates an imminently hazardous situation that, if not avoided, WILL result in DEATH OR VERY SERIOUS INJURY.                                                          |
|  | <b>WARNING</b> | Indicates a imminently hazardous situation that, if not avoided, COULD result in DEATH OR SERIOUS INJURY.                                                               |
|  | <b>CAUTION</b> | Indicates a imminently hazardous situation that, if not avoided, MAY result in MINOR INJURY.                                                                            |
| <b>IMPORTANT</b>                                                                   |                | Identifies special instructions or procedures that, if not strictly observed, could result in damage to, or destruction of the machine, attachments or the environment. |

**NOTE:** *Identifies points of particular interest for more efficient and convenient operation or repair.*

If you have questions not answered in this manual or require additional copies or the manual is damaged, please contact your dealer or the manufacturer directly.

---

## IMPORTANT SAFETY INFORMATION!

Working with equipment can lead to injuries. Read this manual, and the manual for your power unit, before assembly or operating, to acquaint yourself with the machines. It is the implement owner's responsibility, if this machine is used by any person other than yourself, is loaned or rented, to make certain that the operator, prior to operating:

1. Reads and understands the operator's manuals.
2. Is instructed in safe and proper use.

-  The use of this equipment is subject to certain hazards which cannot be protected against by mechanical means or product design. All operators of this equipment must read and understand this entire manual, paying particular attention to safety and operating instructions, prior to using. If there is something in this manual you do not understand, ask your supervisor, or your dealer, to explain it to you.

# SAFETY INSTRUCTIONS (continued)



## EQUIPMENT SAFETY GUIDELINES

Safety of the operator is one of the main concerns in designing and developing a new piece of equipment. Designers and manufacturers build in as many safety features as possible. However, every year many accidents occur which could have been avoided by a few seconds of thought and a more careful approach to handling equipment. You, the operator, can avoid many accidents by observing the following precautions in this section. To avoid personal injury, study the following precautions and insist those working with you, or for you, follow them. Review the safety instructions with all users annually.



This equipment is dangerous to children and persons unfamiliar with its operation. The operator should be a responsible adult familiar with farm machinery and trained in this equipment's operations. **Do not allow persons to operate or assemble this unit until they have read this manual and have developed a thorough understanding of the safety precautions and of how it works.**



Never use alcoholic beverages or drugs which can hinder alertness or coordination while operating this equipment. Consult your doctor about operating this machine while taking prescription medications.



Replace any CAUTION, WARNING, DANGER or instruction safety sign that is not readable or is missing. Location of such safety signs is indicated in this booklet. Do not paint over, remove or deface any safety signs or warning signs on your equipment. Observe all safety signs and practice the instruction on them.



Only use a tractor equipped with a ROPS cab or rollover protective structure. Keep foldable ROPS systems in "locked up" position at all times. Keep seat belt fastened.



Never exceed the limits of a piece of machinery. If its ability to do a job, or to do so safely, is in question – **DON'T TRY IT.**



Do not modify the equipment in any way. Unauthorized modification may impair the function and/or safety and could affect the life of the equipment.



Know your controls and how to stop skid steer, tractor, engine, and loader quickly in an emergency. Read this manual and the one provided with your tractor or skid steer.















In addition to the design and configuration of this implement, including Safety Signs and Safety Equipment, hazard control and accident prevention are dependent upon the awareness, concern, prudence, and proper training of personnel involved in the operation, transport, maintenance, and storage of the machine. Refer also to Safety Messages and Operation Instructions in each of the appropriate sections of the Tractor, Skid Steer, and Implement Manuals. Pay close attention to the Safety Signs affixed to the Tractor, Skid Steer, and the Implement.

# SAFETY INSTRUCTIONS (continued)



## OPERATIONAL SAFETY

-  Start tractor only when properly seated in the tractor seat. Starting a tractor in gear can result in injury or death. Do not mount or dismount the tractor while the tractor is moving. Mount or dismount the tractor only when the tractor and all moving parts are completely stopped.
-  Operate the tractor and/or implement controls only while properly seated in the tractor seat with the seat belt securely fastened around you. Inadvertent movement of the tractor or implement may cause serious injury or death.
-  Keep all helpers and bystanders twenty-five feet (25') from an operating power unit and attached equipment. Only properly trained people should operate this machine. It is recommended the tractor be equipped with a Rollover Protection System (ROPS) and a seat belt that is used. Always stop the tractor, skid steer, or forklift, set brake, shut off the engine, remove the ignition key, and lower loader and attachment to the ground before dismounting. Never leave equipment unattended with the engine running.
-  Please remember it is important that you read and heed the safety signs on the front loader attachment and loader, and the safety rules set forth. Clean or replace all safety signs if they cannot be clearly read and understood. They are there for your safety as well as the safety of others. The safe use of this machine is strictly up to you, the operator.
-  Be sure power unit is in good condition. Read all the safety precautions and make sure all operators are familiar with the safety rules of operation.
-  Never leave the tractor and implement unattended while the implement is in the lifted position. Accidental operation of lifting lever or a hydraulic failure may cause sudden drop of unit with injury or death by crushing.
-  When the use of hand tools is required to perform any part of assembly, installation, adjustment, maintaining, repairing, removal, or moving the implement, be sure the tools used are designed and recommended by the tool manufacturer for that specific task.
-  Never allow children to play on or around tractor or implement. Children can slip or fall off the equipment and be injured or killed. Inadvertent contact with controls can cause the implement to shift or fall crushing themselves or others.
-  Always use two people to handle heavy, unwieldy components during assembly, installation, removal, or moving the loader attachment.
-  Never place any part of your body where it would be in danger if movement should occur during assembly, installation, operation, maintaining, repairing, removal, or moving the implement.
-  The use of any loader attachment is NOT recommended on tractor with a tricycle wheel arrangement. Tricycle type tractors are unstable for front loader use.
-  A heavy load can cause instability in driving a power unit. Make sure the front or rear of the power unit is properly counter-balanced with weights. Always drive slowly – especially around turns. An unstable power unit could steer badly and possibly tip over, causing injury or death.

# SAFETY INSTRUCTIONS (continued)



## OPERATIONAL SAFETY (continued)



Do not allow children or others to ride on the power unit with an operator. Riders are subject to injury such as being struck by foreign objects or being thrown off. Riders obstruct the operator's view resulting in unsafe operation. **Never allow anyone to ride on the implement!**



Before you operate any equipment, check over all pins, bolts and connections to be sure all are securely in place. Replace any damaged or worn parts immediately.



Check that this attachment is securely mounted to the loader. Failure to install lock pins or have the latching mechanism engage could result in injury or death.



Do not work under a raised loader unless it is securely blocked or held in position. Do not depend on the power unit hydraulic system to hold the implement in place.



Operate the loader controls smoothly, avoiding jerky operation. Stop loader gradually when lowering or lifting loads.



Beware of low electrical wires when loader is raised. Serious injury or death can result if contact is made.



When handling bales on a slope, always approach the bale with the power unit facing uphill.



When stacking bales, ALWAYS MAKE SURE BALES ARE PLACED SO THE STACK IS STABLE.



Keep all bystanders at a safe distance. REMEMBER FALLING BALES CAN ROLL OR TUMBLE.



Do not handle loads that exceed the weight limitations of the loader.



Carry the loads slowly and as low as possible to the ground. Avoid excessive speed during operation.



For operator safety, always keep load in front of power unit. NEVER position load back over operator. ALWAYS BE CAREFUL!

















Keep alert and watch the rear as well as the front when working with the loader. Beware of lift clearance when raising loader to maximum height.

# SAFETY INSTRUCTIONS (continued)



## OPERATIONAL SAFETY (continued)

-  Be certain the power unit is in neutral or park position before starting engine.
-  Always shut off power unit and shift to “Park” or set brakes when leaving unit. Always lower bucket or attachment to ground, relieve all hydraulic pressure. Remove key when leaving equipment unattended. Park in level area.
-  Operate loader from operator’s seat only. Remain at controls until operating cycle is complete.
-  Use extreme care when working on inclines and hillsides. Do not operate close to ditches, creeks or holes. Slow down when operating over rough ground.
-  When maneuvering close to buildings or passing through narrow areas, be sure to allow sufficient clearance for the power unit, loader, and load. Drive slowly. Allow for additional length of loader and load on power unit while turning.
-  Always load rear of tractor first and unload last when using a front loader.
-  Never use the tractor/loader to stop a rolling bale.
-  Never allow anyone to walk or work under a raised loader.
-  Be sure that people, livestock, or pets are not standing near the machine while operating.
-  Do not lift or carry anyone on loader or in bucket or on attachment. Do not use loader for a work platform.
-  ALWAYS lower loader to the ground or block securely before performing any maintenance work.
-  Always keep power unit on solid footing when operating loader.
-  Observe Safety Recommendations in loader instruction manual.
-  Inspect the entire machine periodically as indicated in the Maintenance Section of this manual. Look for loose fasteners, worn or broken parts, pinched hydraulic hoses, and leaky or loose fittings. Make sure all pins have cotter pins and washers. Serious injury may occur from not maintaining this machine in good working order.



# SAFETY INSTRUCTIONS (continued)



## TRANSPORT SAFETY



Comply with state and local laws governing highway safety and movement of farm machinery on public roads.



The use of flashing amber lights is acceptable in most localities. However, some localities prohibit their use. Local laws should be checked for all highway lighting and marking requirements.



When driving the tractor and equipment on the road or highway under 20 mph (32 kph) at night or during the day, use flashing amber warning lights and a slow moving vehicle (SMV) identification emblem.



Always be sure the implement is in the proper raised position for transport.



Reduce speed when transporting mounted implements to avoid bouncing and momentary loss of steering control.



Plan your route to avoid heavy traffic. Watch for traffic when operating near or crossing roadways.



Do not drink and drive!



Be aware of the operating conditions. Do not operate the tractor with weak or faulty brakes. When operating down a hill or on wet or rain slick roads, the braking distance increases; use extreme care and reduce your speed in these conditions. When operating in traffic, always use the tractor's flashing warning lights and reduce your speed. Be aware of traffic around you and watch out for the other guy.



Turn curves or go up or down hills only at a low speed and at a gradual steering angle. Make certain that at least 20% of the tractor's weight is on the front wheels to maintain safe steering. Slow down on rough or uneven surfaces, and loose gravel.



Use extreme care and maintain minimum ground speed when transporting on hillside, over rough ground and when operating close to ditches or fences. Be careful when turning sharp corners.



Never allow riders on either power unit or implement. Falling off can kill.



Be a safe and courteous driver. Always yield to oncoming traffic in all situations, including narrow bridges, intersections, etc.



Do not exceed 20 mph (32 kph). Reduce speed on rough roads and surfaces.















Always disengage PTO before driving the tractor to transport the implement from one place to another.

# SAFETY INSTRUCTIONS (continued)



## MAINTENANCE SAFETY

**Good maintenance is your responsibility. Poor maintenance is an invitation to trouble.**





-  Before working on this machine, drive to a level area, disengage the PTO, lower implement or loader (or if working underneath, raise and block securely), shut off the engine, relieve all hydraulic pressure, set the brakes, and remove the ignition keys.
-  Never work under equipment unless it is blocked securely. Never depend on hydraulic system to keep implement in raised position.
-  Do not use blocking made of concrete blocks, logs, buckets, barrels or any other material that could suddenly collapse or shift positions. Use only good quality blocking material.
-  Never operate controls from the ground. Operate the controls only from the operator's station.
-  Keep all persons away from operator control area while performing adjustments, service, or maintenance.
-  Always use personal protection devices such as eye, hand and hearing protectors, when performing any service or maintenance.
-  Periodically tighten all bolts, nuts and screws and check that all cotter pins are properly installed to ensure unit is in a safe condition.
-  When completing a maintenance or service function, make sure all safety shields and devices are installed before placing unit in service.
-  Openings in the skin and minor cuts are susceptible to infection from hydraulic fluid. If injured by escaping hydraulic fluid, see a doctor at once. Gangrene and death can result. Without immediate medical treatment, serious infection and reactions can occur.
-  Never use your hands to locate a hydraulic leak on attachments. Use a small piece of cardboard or wood. Hydraulic fluid escaping under pressure can penetrate the skin. Openings in the skin and minor cuts are susceptible to infection from hydraulic fluid. If injured by escaping hydraulic fluid, see a doctor at once. Gangrene and death can result. Without immediate medical treatment, serious infection and reactions can occur.
-  After servicing, be sure all tools, parts and service equipment are removed.
-  Check to ensure all safety signs are installed and in good condition.

**If equipment has been altered in any way from original design, the manufacturer does not accept any liability for injury or warranty.**

# SAFETY INSTRUCTIONS (continued)



## STORAGE SAFETY

-  Following operation or when unhooking, stop the tractor, set the brakes, shut off the engine, relieve all hydraulic pressure and remove the ignition keys.
-  Store the unit in an area away from human activity. Do not permit children to play on or around the stored unit.
-  Do not park equipment where it will be exposed to livestock for long periods of time. Damage and livestock injury could result.
-  Make sure all parked machines are on a hard, level surface and engage all safety devices. Storage location should be level and solid to make connecting and unconnecting to power unit easy.
-  If blocking is used, make sure it is solid and secure before leaving area.

# SAFETY SIGNS

Keep safety signs clean and legible at all times.

Replace safety signs that are missing or have become illegible.

Replaced parts that displayed a safety sign should also display the current sign.

Safety signs are available from your Distributor or Dealer Parts Department or the factory.

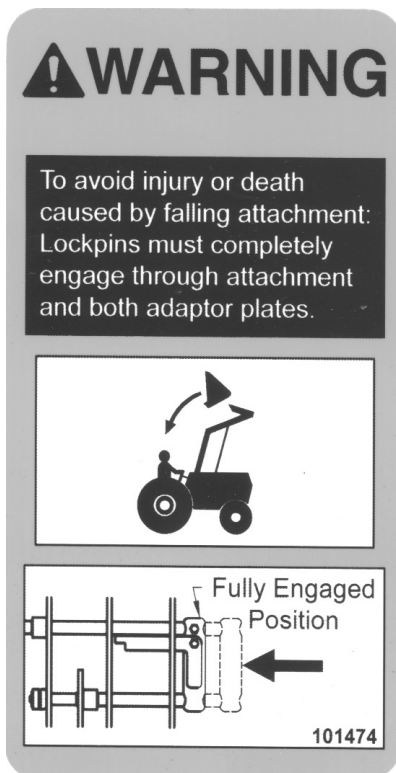

On Model GLBH-2072R



For Model JDBH-2070R only

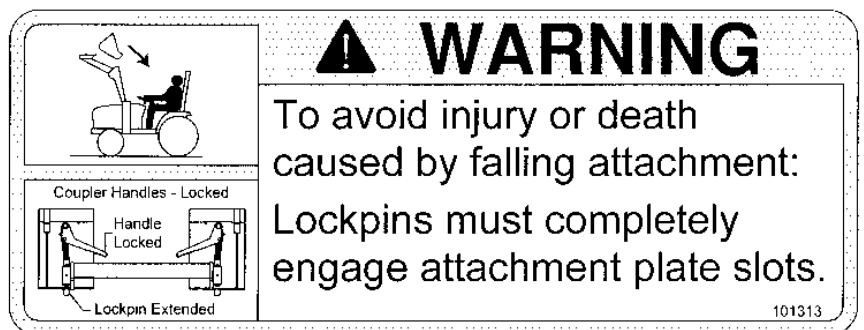

For Models SSBH-2072 & SSBH-2072R

# SAFETY SIGNS

## REPLACING SAFETY SIGNS

1. Clean the area of application with nonflammable solvent.
2. Wash the same area with soap and water.
3. Allow the surface to fully dry.
4. Remove the backing from the safety sign exposing the adhesive surface.
5. Apply the safety sign to the location shown in the parts diagram.
6. Smooth out any bubbles.

**Helpful Hints:** (1) Decals adhere to a warm surface better than a cold surface. (2) Applying heat (from a hair dryer) will greatly improve your ability to remove a damaged decal before preparing the surface for installation of a new one.



### BE CAREFUL!

Use a clean, damp cloth to clean safety decals. Avoid spraying to close to decals when using a pressure washer; high-pressure water can enter through very small scratches or under edges of decals causing them to peel or come off.

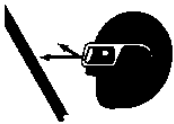
 <b>WARNING</b>	
	
<b>HIGH-PRESSURE FLUID HAZARD</b>	
To prevent serious injury or death:	
<ul style="list-style-type: none"><li>• Relieve pressure on system before repairing or adjusting or disconnecting.</li><li>• Wear proper hand and eye protection when searching for leaks. Use wood or cardboard instead of hands.</li><li>• Keep all components in good repair.</li></ul>	
101122	

## **WARNING**

- Read and follow owner's manual before installing, operating, or performing maintenance on this attachment. Observe safety recommendations in manual.
- Do not exceed weight limit of attachment of tractor.
- Attachment should be used with the proper weight package on front of tractor or with a loader installed. When handling loads on both ends of tractor, load rear first and unload last.
- Set wheels wide for increased stability.
- Never take load to extreme heights on steep inclines.
- When handling large round bale, keep load as low as practical to maximize tractor stability.
- Make sure large round bale transported on tractor near three point hitch attachment does not obstruct visibility of tractor's flashing lights or SMV sign.
- Do not stand or walk under raised attachment.
- Stop engine, lower arm, relieve all hydraulic pressure, and lock brakes before leaving operator's seat.
- Failure to follow the above precautions can result in serious injury or death.

101277

### REMEMBER:

If Safety Signs have been damaged, removed, become illegible or parts replaced without Signs, new Safety Signs must be applied. New Safety Signs are available from your authorized distributor or factory.

# INSTRUCTIONS

## TRACTOR REQUIREMENTS AND PREPARATION

The Model UBH-2072 and the UBH-2072R Bale Hand attachments are designed to fit most farm tractor double-cylinder front-end loaders. Optional brackets are available to fit most popular quick coupler front-end loaders.

The Model SSBH-2072 and SSBH-2072R are designed for skid steer loaders and tractor front loaders equipped with the Universal Quick-Attach.

The Model JDBH-2072R Bale Hand is designed for John Deere Tractors with the 400/500 Series tractor front loaders equipped with 400/500 style carriers.

The Model GLBH-2072 and GLBH-2072R Bale Hand are designed for farm tractors equipped with front loaders with Euro/Global Quick-attach.

The Bale Hand can handle large round bales from 36" to 80" in diameter and weighing up to 2,200 pounds.

Bales can be handled with care from nearly any direction and can be stacked on the ends or sides. Most handling of plastic wrapped bales is on their ends where the plastic is 18 to 30 layers thick. Wrapped bales can be grabbed on their diameters with some care.

**NOTE:** The standard Bale Hand will require a tractor of at least 40-50 hp in size. The rotating Bale Hand ("R" Series) will require a tractor of 60-80 hp in size. The loader or skid steer unit also needs to have sufficient lift capacity to handle the bale and the weight of the Bale Hand.

Both the standard Bale Hand and the "R" Series, will gently handle large round wrapped/unwrapped bales up to 2,200 lbs. It features smooth curved clamping arms to prevent puncturing wrapped bales, yet securely clamping them during transport.

The "R" Series is offered in Euro/Global mount, JD 400/500 Series mount, Skid Steer mount and blank to accept our bolt on brackets. Power unit needs to be equipped with two auxiliary valves or a solenoid kit is required. The power unit needs to have sufficient lifting capacity to handle the bale, make sure the power unit is properly counter-balanced with weight prior to moving bales.

The ROTATING BALE HAND 2 1/2" x 10" rotation cylinder has .40" restricting orifices in the 90° fittings to control the speed of rotation.



## CAUTION

**Be sure your tractor and loader, or skid steer are in good condition. Read all the safety precautions and make sure all equipment operators are familiar with the safety rules of operation.**

Check the tractor's hydraulic system. Be sure the hydraulic oil and filter have been serviced according to manufacturer's recommendations. Refer to your tractor or loader operator's manual or dealer for any adjustments necessary to put the hydraulic system in good working order.

Be sure tires and rims are in good condition. Inflate tires to the proper recommended air pressure.

The operator is responsible for the safe operation of this equipment. The operator must be properly trained. Operators should be familiar with the tractor, loader and loader attachment, and all safety practices before starting operation. Read the safety rules and safety signs on pages 3-11.



## WARNING

■ **Power unit must be equipped with ROPS or ROPS cab and seat belt. Keep seat belt securely fastened. Falling off power unit can result in death from being run over or crushed. Keep foldable ROPS systems in "locked up" position at all times.**

■ **A heavy load can cause instability in driving a power unit. Make sure the rear of the tractor is properly counter-balanced with weights. Always drive slowly – especially around turns. An unstable unit could steer badly and possibly tip over, causing injury or death.**

# INSTRUCTIONS (continued)

## ASSEMBLY

This unit is shipped partially assembled. Carefully follow instructions for final assembly.

Before attempting assembly check the following items. Having all the needed parts and equipment readily at hand will speed up your assembly task and will make the job as safe as possible.

- Check for fasteners and pins that were shipped with the bale hand. All hardware coming from the factory has been installed in the location where it will be used. If a part or fastener is temporarily removed for assembly reasons, remember where it goes. Keep the parts separated.
- Have a fork lift or loader along with chains and safety stands that are sized for the job ready for the assembly task.
- Have a minimum of 2 people at hand during assembly.
- Check to see that all nuts are tightened.

Remove the bucket from your front end loader or skid steer. Check your loader to make sure it is in good working order. Check all frame mounting bolts to make sure they are tight.

Loaders that attach to the tractor frame rails should have a cross-tie installed for stability.

Refer to the “exploded view” of the Bale Hands on pages 23 and 25 of this manual.

## ASSEMBLY OF LIFT BRACKETS – UBH-2072 & UBH-2072R ONLY

Assemble the two lift brackets on the main frame (Ref. #1 – page 23) with the  $\frac{5}{8}$ " x 3" I.D. U-bolts. Leave the U-bolts loose.

**NOTE:** The pin-on lift channel brackets are supplied with 1" diameter pins to fit your loader. If your loader requires  $1\frac{1}{8}$ " pins, it will be necessary for the hole diameter in the channel brackets to be drilled out to  $1\frac{5}{32}$ " (1.156") and ask your dealer to order  $1\frac{1}{8}$ " diameter pins. The  $1\frac{1}{8}$ " pins are part #830318. Be sure to indicate if two or four  $1\frac{1}{8}$ " pins are required.

If your loader requires  $1\frac{1}{4}$ " diameter pins, please ask your dealer to order adapter bushings (part #830319). Be sure to indicate how many adapter bushings are required.

**NOTE:** The Ford Model 7109, 7209, 7210 and 7410 Loaders require special mounting brackets instead of the standard lift channels supplied. Order #830330 for these applications.

Connect the above assembly to the loader arms using the bottom hole in the channel and attach the upper control cylinder to the top hole in the lift channels. Center the main frame (side to side) with your loader arms and tighten the four (4)  $\frac{5}{8}$ " x 3" U-Bolts.

The lower hole positions in the lift channels can be used to obtain more angle movement. However, if the frame becomes too parallel with the loader lift arms, the loader may not have enough power (mechanical advantage) to bring the frame back.

**NOTE:** Generally, it is not recommended to have the tilt cylinders located any closer than 8-10 inches to the main loader lift arms. Check the spacing of mounting pins on your loader bucket and use this as a guide.

If tilt cylinders are located too close to the loader arms, they may go “over center” when fully extended. If this happens, damage may occur to the cylinders and/or mounting brackets.

If your tractor loader has a bucket Quick Attach feature, check with your dealer on the availability of adapter brackets for your brand and model loader.

**NOTE:** The Bale Hand Models SSBH-2072, SSBH-2072R, JDBH-2072R, and GLBH-2072R have special quick-attach brackets on the frame. No lift channel brackets are required.



**To help prevent personal injury, stand clear of frame and loader. Keep feet away from underside of main frame.**

# INSTRUCTIONS (continued)

## **ASSEMBLY (continued)**

The Bale Hand Models have a bolt-on anti-roll back guard to keep bales from rolling back down the loader arms and possibly injuring or killing the operator.

Make sure this part (Ref. #9) is bolted securely to the Bale Hand frame (Ref. #1) – page 23.

For the “R” Models part (Ref. #7) bolts to the frames (Ref. #1A, 1B, 1C and 1D) on page 25.



### **DANGER**

**Never operate Bale Hand without anti-roll back guard in place.**

**Operation without this guard in place could result in serious injury or death.**

With the frame mounted on the power unit, raise the loader so that the bottom of the frame is 8”-10” off the floor. Place good blocking under the frame for safety.

Using a hoist or other lifting means, lift one of the arm weldments in an upright position (like pictured in the exploded view) and maneuver the end of the arm between the large flat plates on the front of the main frame. Align the hole in the end of the smaller diameter tube with the hole in the corner of the flat plate. Install one of the Pivot Pin weldment pins through the hole in the plate and into the tube. Repeat this on the bottom plate and install a 3/8” x 1½” carriage bolt to lock the pin weldment to the flat plate. Repeat this procedure with the other clamp arm. Swing the arms to make sure that they swing freely.

Check all bolts and hydraulic fittings. Make sure they are tightened properly.

**NOTE:** For the **NON-ROTATING** Models UBH-2072, GLBH-2072 and SSBH-2072 Bale Hands, the hydraulic fittings are **NOT** supplied for the hydraulic 3” x 10” cylinder that operates the clamp arms.

It is recommended that you purchase and install two 90° hydraulic fittings in the 3” x 10” hydraulic cylinder. The cylinder has ¾” – 16 ORB (SAE 8) ports. These are for O-Ring style fittings that do not require thread sealant.

**NOTE:** For the **ROTATING** 2072R Models, the hydraulic fittings are supplied and installed in the ports of the 3” x 10” hydraulic cylinder. The direction of the fittings is important – it is recommended that you use them as installed at the factory.

**NOTE: ROTATING BALE HAND** Mounted on most skid steer units will require an optional solenoid valve kit (#832799). This is because most skid steer power units have only one pair of remote hydraulic outlets.

**NOTE:** On **ROTATING BALE HAND** models the hoses to the 3” x 10” clamp arm cylinder run thru the hole in the main pivot. They connect to fittings in a plate at the rear of the pivot assembly. Hydraulic hoses from the hydraulic remote connections on the power unit, connect to the fittings on the back side of this plate. Check page 29 to view the schematic drawing.

**NOTE:** The **ROTATING BALE HAND** 2 1/2” x 10” rotation cylinder has .40” restricting orifices in the 90° fittings to control the speed of rotation.

Because the length of hose required to go from the attachment to the location of the power units remote hydraulic outlets can vary, the hoses are not supplied.

Route the hoses back to your power unit control valve. Be sure to allow a loop of hose just behind the attachment to allow for the tilt angles that will be encountered. Make sure that the hoses are routed so they will not be pinched or snagged by attachment pivot arms, loader, or tractor parts. Fasten the hoses securely so they will remain in the correct position and not drop down where they could be pinched or sheared.

**NOTE:** The main pivot between the mounting frame and the rotating head has been lubricated at the factory. Keep this pivot point well lubricated. There are two grease zerks on this pivot.

## **GREASE THE CLAMP ARM PIVOT POINTS**

Operate the clamp arms several times to work the air out of the system. If you have the rotating Bale Hand, rotate the unit back and forth several times.

Check the hydraulic hoses and make sure they are not pinched or stretched tight when operating the Bale Hand and loader.

# INSTRUCTIONS (continued)

## MODEL SSBH-2072 & SSBH-2072R ATTACHMENT TO PRIME MOVER



### WARNING

Improper attachment of the Bale Hand could result in injury or death. Do not operate this product until you have positive indication that the attachment is securely mounted.

1. Position the attachment on a level surface.
2. The quick attach coupler handles should be in the unlocked position with lock pins retracted, Figure 2.

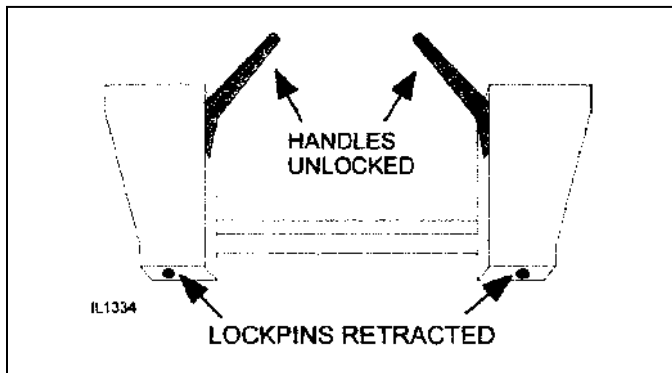

Figure 2. Quick Attach Coupler Handles - Unlocked

3. Enter the prime mover. Fasten seatbelt, start engine. Disengage the parking brake.
4. Follow the attaching procedure in the prime mover owner's manual. Align the attachment mechanism with the mounting on the bale hand, attach to the prime mover on loader.
5. Engage the parking brake and shut down the prime mover. Be sure to relieve pressure to the auxiliary hydraulic lines.
6. Unfasten safety restraints and exit the prime mover.
7. Engage the latching mechanism to secure attachment to loader. The lockpins must be completely extended and secured into the retaining slots.
8. Re-enter the prime mover. Fasten seatbelt and re-start engine.

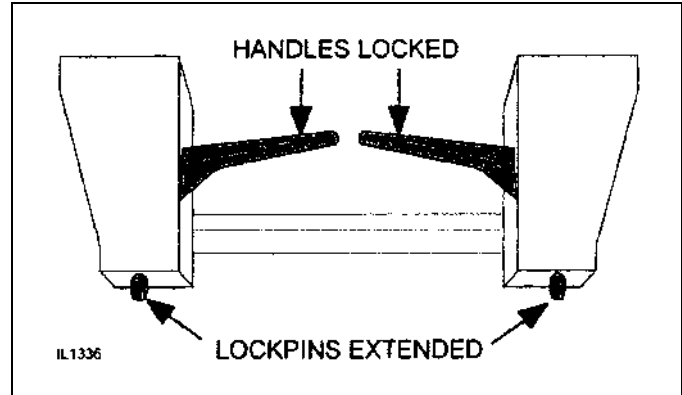

Figure 3. Attachment Coupler Handles - Locked



### WARNING

Attachment coupler handles must always be rotated to LOCK POSITION to prevent coupler latch from disengaging and attachment from falling off.

9. Carefully raise the loader and cycle the rollback/tilt cylinders to check clearances and to ensure that the attachment is securely mounted.

## REMOVING THE SSBH-2072

1. If possible, find a level solid location to place the attachment. This makes it easier to disconnect and re-connect later on.
2. Lower the attachment to the ground.
3. Engage the parking brake and shut down the prime mover. Be sure to relieve pressure to the auxiliary hydraulic lines.
4. Unfasten safety restraints and exit prime mover.
5. Disengage attachment-locking mechanism (mechanical type).
6. Enter prime mover, fasten safety restraints and start the prime mover.
7. Disengage attachment-locking mechanism (hydraulic type).
8. Disengage the parking brake, and back away from the attachment.



# INSTRUCTIONS (continued)

## **MODEL GLBH-2072 & GLBH-2072R ATTACHMENT TO PRIME MOVER**

The Models GLBH-2072 and GLBH-2072R are specifically designed for tractor front loaders with the Euro or Global bucket quick-change system.

### **ATTACHING**

1. To prepare the loader for attachment, pull and rotate handle to open latch (A).
2. Extend attachment cylinders to angle attaching brackets forward.
3. Drive forward, adjusting loader height and position until the bar (B) is under hooks (C) and tabs (D) are on the center side of the hooks.

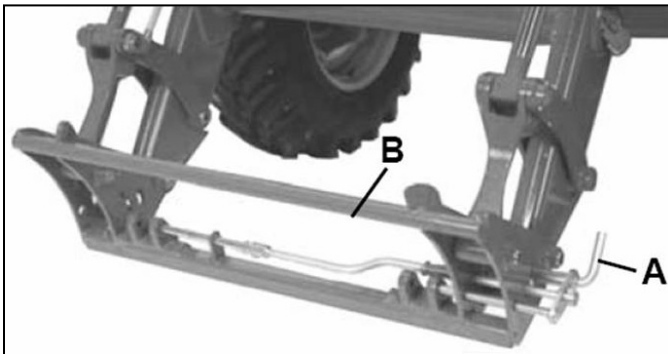

**NOTE: Latch automatically closes on some global carrier. Always check latch pins.**

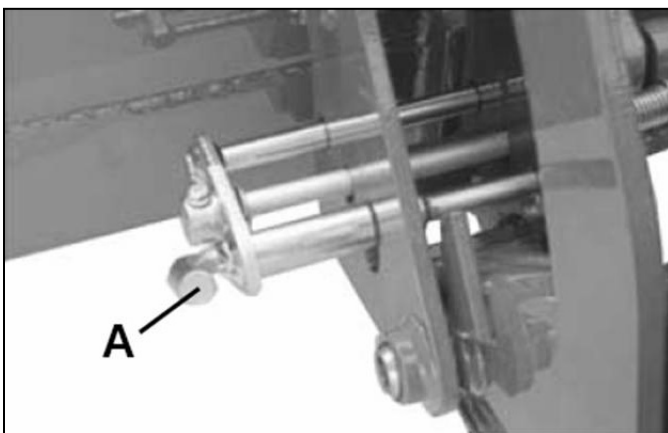

4. Raise loader and retract tilt cylinders until latch closes.
5. Lower attachment and shut off engine. Installation is now complete.

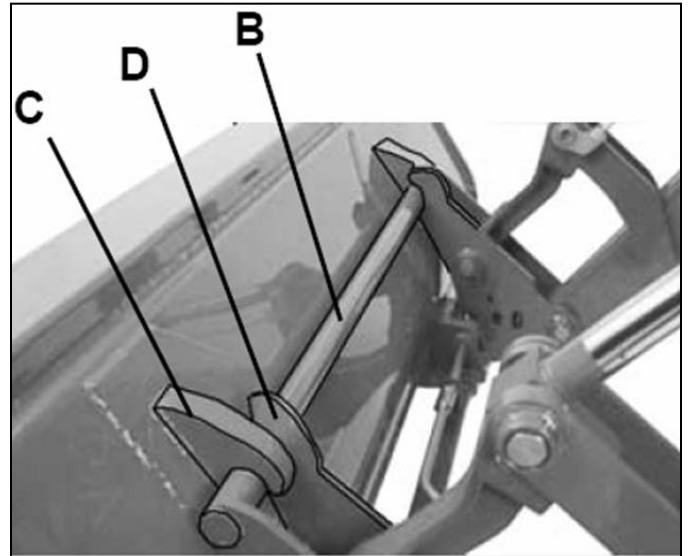

**CAUTION!**



**ALWAYS CHECK LATCH PINS  
BEFORE TILTING OR OPERATING  
ANY ATTACHMENT.**

### **DETACHING**

1. Lower bale hand to ground. Place the transmission in PARK and shut off engine and remove key.
2. Pull and rotate handle to open latch (A).
3. Start tractor and lower attachment to ground. Slowly extend bucket tilt cylinders until loader clears the latch plate. Lower loader until bar clears the hooks.
4. Drive tractor in reverse until loader is clear of the attachment.

**OBEY ALL SAFETY WARNINGS!**

# INSTRUCTIONS (continued)

## MODEL JDBH-2072R ATTACHMENT TO PRIME MOVER

The Bale Hand Model JDBH-2072R is specifically designed for John Deere 400 and 500 style carriers.

**NOTE: Procedure is the same for all attachments. Bucket attachment shown.**

### ATTACHING

1. Extend bucket tilt cylinders to angle attaching brackets forward.

**NOTE: Angle must be greater than that of the brackets on the rear of the bale hand.**

2. Drive forward, adjusting loader height and position until the top of the loader bracket engages the hooks (C) on the bale hand.
3. Slowly retract the bucket tilt cylinders and raise the loader so the lower lock pins (F) engage the hole in the holder strap (E).
4. Continue to retract the tilt cylinders and raise the loader until the main frame of the bale hand is vertical.
5. Engage tractor parking brake and/or place transmission in PARK. Shut off tractor engine and remove key.
6. Install the quick-lock-pin (A) into the pins (F) on each side of the bale hand.

Installation is now complete.

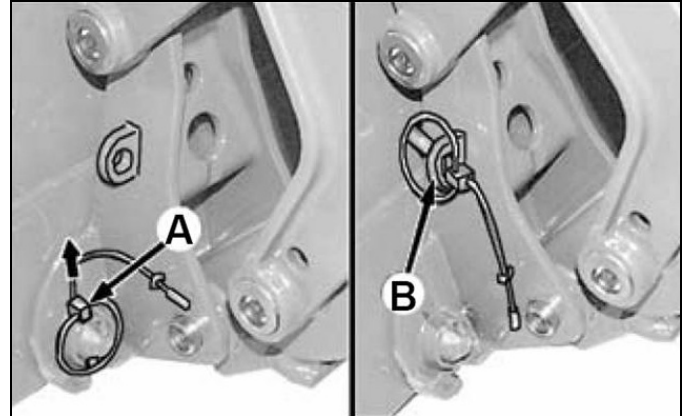
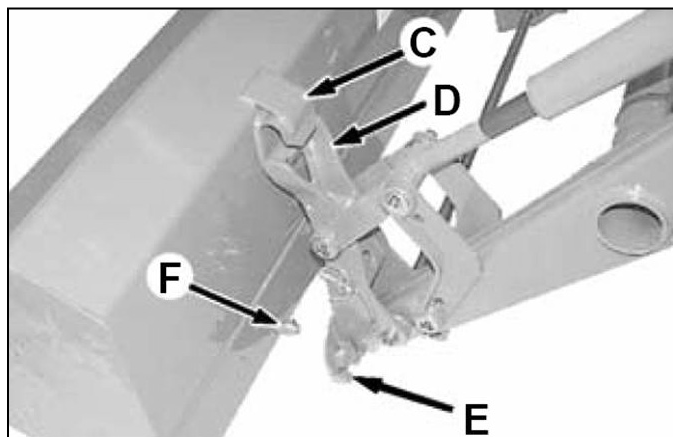

**NOTE: On attachments with two pins (F), the 400 series loaders will utilize the upper pin and the 500 series loader will utilize the lower pin.**

### CAUTION!



**ALWAYS CHECK LATCH PINS BEFORE TILTING OR OPERATING ANY ATTACHMENT.**

### DETACHING

1. Engage tractor parking brake and/or place transmission in PARK. Shut off tractor engine and remove key.
2. Remove the quick lock-pin (A) from each side of attachment. Store pins in storage position (B).
3. Start engine and lower the bale hand to the ground. Extend bucket tilt cylinders until pin (F) releases from holder strap (E) on each side of attachment. Lower the loader until holder brackets are free from the hooks. Back tractor away from attachment.
4. Set parking brake and/or place transmission in PARK. Shut off engine and remove key.

**REPLACE SAFETY SIGNS  
IF DAMAGED OR MISSING.**

# OPERATING INSTRUCTIONS

## PRE-OPERATION CHECKLIST

(OWNER/OPERATOR RESPONSIBILITY)

- \_\_\_ Review and follow safety rules and safety signs on pages 3 through 11.
- \_\_\_ Check that Bale Hand is properly and securely attached to tractor loader or skid steer.
- \_\_\_ Lubricate all grease fitting locations.
- \_\_\_ Check that all hardware is properly installed.
- \_\_\_ Check that no one enters the area of machine operation.
- \_\_\_ Know your controls and how to stop tractor, engine and PTO quickly in an emergency. READ THIS MANUAL AND THE ONE PROVIDED WITH YOUR TRACTOR AND LOADER.
- \_\_\_ To avoid accident or injury, do not allow anyone to operate this equipment without proper instructions. Any person who operates this equipment must be instructed in and be capable of the safe operation of the power unit, implement and all controls.

## OPERATION

The operator is responsible for the safe operation of this equipment. The operator must be properly trained. Operators should be familiar with the equipment, the tractor, and all safety practices before starting operation.

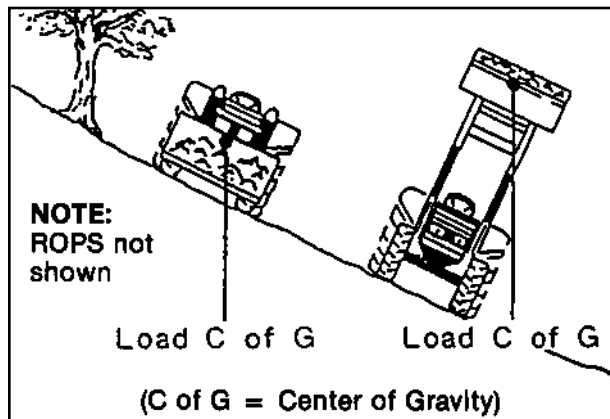

When working on side hills, **DO NOT RAISE LOADER TOO HIGH.** Keep an eye on terrain changes. Keep load low.

## HANDLING BALE BY ITS END

Using the bucket tilt cylinders, adjust the angle of the Bale Hand so that the open outer ends of the clamp arms are hanging down 45° to 60°. Approach the bale slowly with the Bale Hand raised above the bale. When you are above the bale, lower your loader so that the Bale Hand gently drops onto the bale at the 45° to 60° angle. This method is also best for releasing a bale, as it provides you the best visibility of the bale and clamp arm ends.

When the Bale Hand is correctly positioned, apply pressure to the clamp arm cylinder and firmly grasp the bale. Then, using the tilt cylinders, rotate the bale up and back so that the loader is carrying the bale tilted back 15° to 30°.

It is recommended that the bale be tilted back when transporting. Always carry a bale with the loader in a low position so that you have good visibility and a low center of gravity.

When handling bales for the first time or different bales, always raise the bale only six (6) inches above the ground and get off the tractor and check the Hand and bale. Make sure that there is no slippage of the bale from the Bale Hand's grasp. Any slippage would indicate inadequate hydraulic clamping pressure.

If you are handling plastic wrapped bales, check to make sure that the plastic wrapping is not being damaged. If damage is encountered, it may be necessary to grasp the bale differently.

## HANDLING BALE BY ITS DIAMETER

To grasp the bale by its diameter, it is best to position the Bale Hand with its open clamp arm ends either straight out (forward) or tilted straight down. The latter position is used when you wish to rotate a bale laying on its side so that it may be stacked on its end.

Approach the bale slowly and with the Bale Hand above the bale. When the Bale Hand is over the bale, lower the loader and position the bale within the open clamp arms of the Bale Hand. Grasp the bale firmly with the hydraulic operated clamp arms.

As mentioned earlier, check the Bale Hand and bale for proper clamping before attempting to transport or raise any distance.

When stacking plastic wrapped bales, check the ground surface area for any sharp stalk ends, sharp rocks or other projections that could puncture a hole in the plastic covering and cause spoilage.



**CAUTION**

**Beware of lift clearance when raising loader to maximum height.**

# OPERATING INSTRUCTIONS (continued)

## ROTATING THE BALE

Generally, round bales are being rotated to stack them on end for storage or loading them on trucks or trailers.

Once the bale is properly clamped, lift the bale and back away from the stack of bales or any other object that the bale could contact.

Have the Bale Hand at least a few feet off the ground and engage the hydraulic cylinder that rotates the bale. This can be done while traveling to the selected location to place the bale, which will save time.

Check the immediate areas around the bale for sufficient clearance, and then place the bale into position and unclamp. Back away and get the next bale.



## WARNING

- **Rear ballast is required to ensure 25% of gross vehicle weight is transferred to the rear axle. Attachment and load must be included as weight. Adequate rear weights are required to counterbalance maximum loader capacity and safe loader operation. Weight can be added as rear tire liquid, rear wheel weights, rear axle weights and/or three point hitch mounted ballast or implement. Ballasting will vary with tractor and loader attachment. Refer to the Tractor manual for recommended ballasting.**
- **Never allow children or untrained persons to operate equipment.**
- **Keep bystanders away from equipment.**
- **Never allow riders on power unit or attachment.**



## WARNING

- **Do not operate this product until you have positive indication that this attachment is securely mounted to the loader. Failure to install lock pins or have the latching mechanism engaged could result in injury or death.**
- **Power unit must be equipped with ROPS or ROPS cab and seat belt. Keep seat belt securely fastened. Falling off power unit can result in death from being run over or crushed. Keep foldable ROPS systems in “locked up” position at all times.**

When stacking hay bales or loading vehicles, make sure you are operating in an area AWAY FROM OVERHEAD WIRES.



## DANGER

**Beware of low electrical wires when loader is raised. Serious injury or death can result if contact is made.**

**Do not leave the operator’s seat if any part of the power unit, loader or attachment contacts electric lines.**

## HANDLE ROUND BALES SAFELY

Improper use of loaders to handle round bales can result in serious injury or death to the tractor/loader operator. This could be caused by the bale rolling back down the loader into the operator’s station.

For optimum stability and visibility:

- Do not handle bales that exceed the bale weight limitations of the loader.
- Carry the bale slowly and as low as possible.
- Operate loader controls smoothly, avoid jerky operation.
- When handling round bales on a slope, always approach the bale with the power unit facing uphill.
- Never use the tractor/loader to stop a rolling bale.
- Only use a power unit equipped with a ROPS cab or roll-over protective structure.
- Use care when working on inclines and hillsides.
- Avoid holes, ditches, and obstructions which may cause tractor/loader to tip.
- Operate loader from operator’s seat only. Remain at controls until operating cycle is complete.
- Lower bucket or attachment to ground when loader is unattended.
- When stacking bales, ALWAYS MAKE SURE BALES ARE PLACED SO THE STACK IS STABLE.
- Keep all bystanders at a safe distance. REMEMBER – FALLING BALES CAN ROLL OR TUMBLE.
- **NEVER LET ANYONE CLIMB ON STACKED ROUND HAY BALES.**

# OPERATING INSTRUCTIONS (continued)

## TRANSPORTING

---

### CAUTION

When traveling on public roads, whether at night or during the day, use accessory light and devices for adequate warnings to operators of other vehicles. Comply with all federal, state and local laws.

Allow for additional length of loader and attachment on power unit while turning.

Check visibility. If visibility is impaired, reduce speed or consider other means of transport.

Read all the safety warnings in the front of this manual and in the manual of power unit.

### WARNING

Transport the loaded bale hand at a slow speed and with the loader at the lowest transport position to avoid tipping or upsetting, which could result in serious injury or death.

When traveling over rough or hilly terrain or when making turns, slow down and use extra care.

## MAINTENANCE & STORAGE

---

Replace any worn or damaged parts immediately. Do not use attachment with any damaged parts.

### WARNING

■ Always stop the tractor or skid steer, set brake, shut off engine, remove key, and lower loader to ground before attempting to service. Never leave equipment unattended with engine running.

■ Do not work under a raised loader unless it is securely blocked or held in position. Do not depend on the hydraulic system to hold loader and attachment in place.

■ Keep all persons away from operator control area while performing adjustments, service, or maintenance.

Check the pins at the ends of the loader arms. Make sure they are locked in place with the linchpins.

Periodically check all bolts to make sure they are tight.

Check hydraulic hoses. Make sure they are not chafed or pinched. Replace any damaged hose.

Check hydraulic hoses and fittings for leaks. Repair any leaks immediately. Never use your hand to check for a hydraulic leak when system is under pressure.

Periodically lubricate the swing arm pivot bushings.

Thoroughly clean the grease zerks before servicing. Dirt mixed with lubricant will rapidly wear parts and destroy bearings. Keep it clean.

If the machine is used in heavy duty conditions, the maintenance operations must be carried out more frequently.

### DANGER

Escaping hydraulic fluid under pressure can penetrate the skin, causing serious injury.

**DO NOT use your hand to check for leaks. Use a piece of cardboard or paper to search for leaks.**

**Stop engine and relieve pressure before connecting or disconnecting lines.**

**Tighten all connections before starting engine or pressurizing lines.**

**If any fluid is injected into the skin, obtain medical attention immediately, or gangrene may result.**

## STORAGE

---

- At the end of the working season or when the Bale Hand will not be used for a long period, it is good practice to clean off any dirt or grease that may have accumulated.
- Inspect the Bale Hand for loose, damaged or worn parts and adjust or replace if needed.
- Store with clamp arms open so hydraulic cylinder is closed to protect the cylinder rod. If this is not possible, smear grease on the cylinder rod.
- Sand areas where paint is chipped or worn and repaint to prevent rust. Lubricate all pivot locations on Bale Hand to prevent moisture damage during storage.
- Storage location should be level and solid to make hitching and unhitching easy. Store in a clean, dry location away from children and livestock.

# TROUBLESHOOTING GUIDE

---

<b>PROBLEM</b>	<b>POSSIBLE CAUSE</b>	<b>POSSIBLE REMEDY</b>
<b>Bale slips from Bale Hand grasp.</b>	<ol style="list-style-type: none"><li>1. Clamp arms not positioned correctly on Bale.</li><li>2. Not firmly clamped by hydraulic cylinder.</li><li>3. Hydraulic system has leak – allowing clamping pressure to back off.</li><li>4. Bale is wrapped with slick net wrap.</li></ol>	<p>Reposition clamp arms.</p> <p>Operate hydraulic cylinder to clamp tighter.</p> <p>Find leak and repair (could be O-Ring in valve).</p> <p>Cut old inner tube into strips and wrap bale hand arms. Use good adhesive to secure to steel tubing.</p>
<b>Bales and/or plastic covering being torn when lowering Bale Hand on bale.</b>	<ol style="list-style-type: none"><li>1. Clamp arms not open wide enough.</li><li>2. Careless driving and/or loader operation.</li><li>3. Not enough plastic on bale.</li></ol>	<p>Open arms wider.</p> <p>Change operators or retrain.</p> <p>Add more wraps of plastic.</p>
<b>Tilt cylinders won't pull Bale Hand back after positioning clamp arm ends straight down.</b>	<ol style="list-style-type: none"><li>1. Loader tilt cylinders are too close to loader arm pins in lift channels.</li><li>2. Loader too small for weight of bale being handled.</li><li>3. Hydraulic system not operating at correct pressure.</li></ol>	<p>Move further apart.</p> <p>Use larger tractor with larger size loader.</p> <p>Check pressure and adjust or repair.</p>
<b>Bale is off to one side of tractor and loader.</b>	<ol style="list-style-type: none"><li>1. Lift brackets on frame not set correctly.</li></ol>	<p>Loosen brackets and measure from center of frame to position correctly.</p>
<b>Bale shape is greatly distorted when clamped.</b>	<ol style="list-style-type: none"><li>1. Bale too soft.</li><li>2. Excessive hydraulic pressure.</li></ol>	<p>Re-adjust baler to have firmer bale.</p> <p>Re-adjust hydraulic pressure or change cylinder to one with smaller bore.</p>

# TROUBLE-SHOOTING GUIDE (continued)

PROBLEM	POSSIBLE CAUSE	POSSIBLE REMEDY
<b>Bale Hand will not operate.</b>	1. No or insufficient oil flow.	<p>Remote hydraulic connection fittings not compatible. Check for proper fitting.</p> <p>Hydraulic system may not be supplying rated pressure. Consult your dealer.</p> <p>Hydraulic system may not be delivering its rated volume of oil due to wear. Hydraulic pump may need to be repaired.</p> <p>Hydraulic valve on tractor or skid steer not engaged.</p>
<b>Hydraulic hose failure.</b>	<p>1. Hydraulic relief pressure setting is very high and may cause hydraulic hose failure.</p> <p>2. Hoses are worn or frayed.</p> <p>3. Hose rating may be too low for hydraulic system pressure.</p> <p>4. Hose is being pinched by movement of loader mount or loader linkage.</p>	<p>Check hydraulic system and adjust relief valve.</p> <p>Replace hose.</p> <p>Replace with higher rated hoses.</p> <p>Reroute hose and refasten.</p>
<b>Hydraulic oil overheats.</b>	<p>1. Hydraulic oil level in power unit may be low.</p> <p>2. Hydraulic oil or oil filter in power unit may be dirty.</p> <p>3. Hydraulic oil reservoir of power unit may be small.</p>	<p>Check and add oil.</p> <p>Change oil and filter according to power unit manufacturer's recommendations.</p> <p>Allow time for oil to cool down.</p>
<b>Excessive rear tractor tire slippage.</b>	<p>1. Tractor too small.</p> <p>2. Insufficient traction.</p>	<p>Use larger, heavier tractor.</p> <p>Add rear tire weights or add ballast in tire. Use tractor with FWDA.</p> <p>Install heavy implement on rear 3 pt. for counterbalance weight.</p>

# UBH-2072, GLBH-2072 & SSBH-2072 PARTS VIEW NON-ROTATING BALE HAND

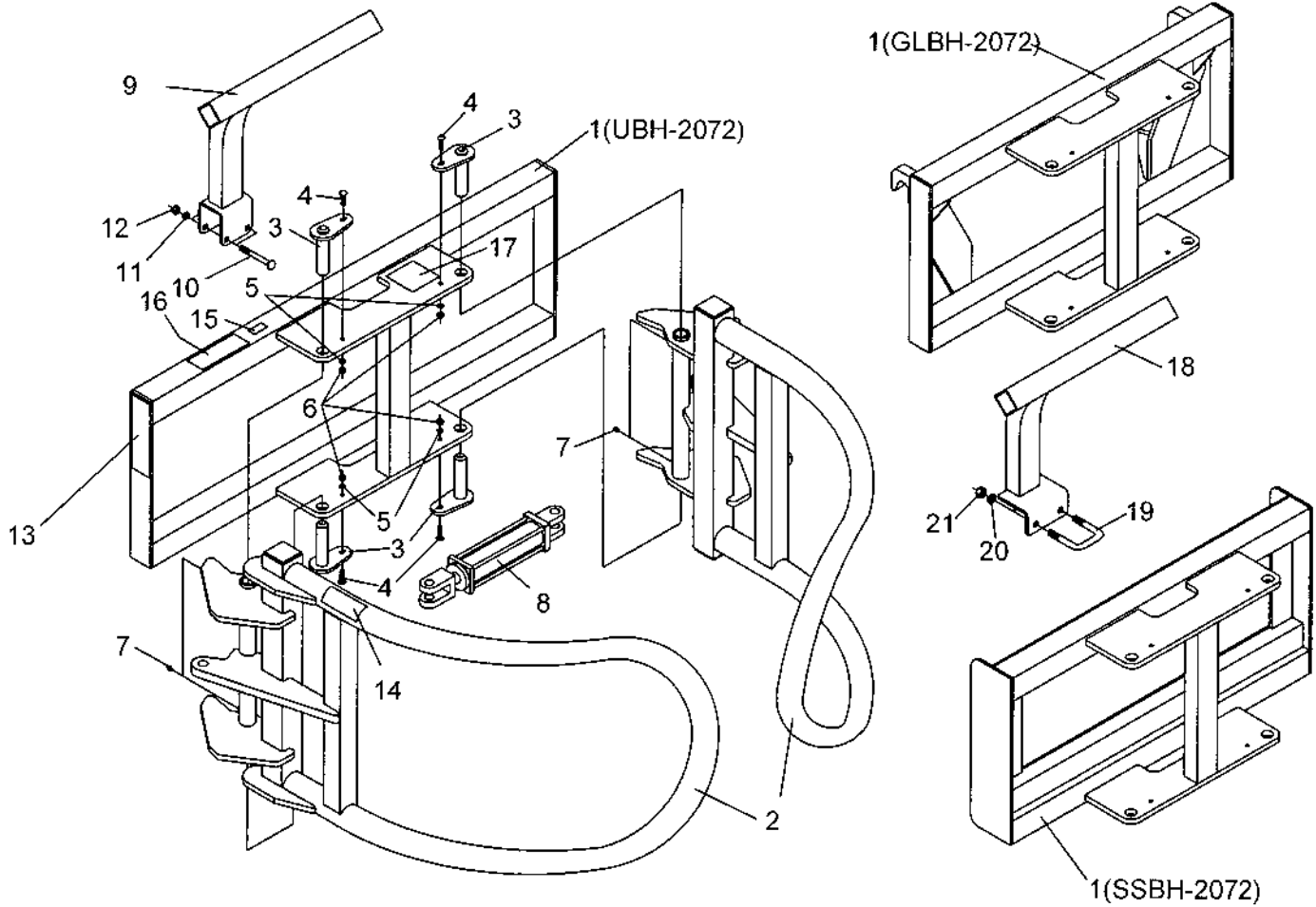



**UBH-2072, GLBH-2072 & SSBH-2072  
PARTS LIST  
NON-ROTATING BALE HAND**

Ref. No.	Part No.	Description	No. Req'd.
1	832945	Main Frame Weldment (UBH-2072 only)	1
	832981	Main Frame Weldment (GLBH-2072 only)	1
	832966	Main Frame Weldment (SSBH-2072 only)	1
2	832970	Arm Weldment	2
3	832857	Pivot Pin Weldment	4
4	2503103	Bolt 3/8"-16NC x 1 1/2" Carriage Head Gr. 2	4
5	2502008	Washer 3/8" Springlock	4
6	2500004	Nut 3/8"-16NC Full Hex	4
7	2504049	Grease Zerk 5/16"	4
8	2504259	Hydraulic Cylinder 3 x 10	1
9	832958	Backstop Weldment (UBH-2072 & GLBH-2072 only)	1
10	2503217	Bolt 1/2"-13NC x 4 1/2" Carriage Head (UBH-2072 & GLBH-2072 only)	2
11	2502002	Washer 1/2" Springlock	2
12	2500003	Nut 1/2"-13NC Full Hex	2
13	101026	Safety Sign - Caution (Instructions)	1
14	101027	Safety Sign - Warning (Stand Clear)	2
15	101041	Safety Sign - Notice (2000 Lb. Capacity)	1
16	101034	Safety Sign - Caution (Hay Equipment)	1
17	101122	Safety Sign - Warning (Hi-Pressure)	1
18	815151	Backstop Weldment (SSBH-2072 only)	1
19	940009	U-Bolt 5/8"-11NC x 3" ID x 4"	1
20	2502007	Washer 5/8" Springlock	2
21	2500013	Nut 5/8"-11NC Full Hex	2

# SSBH-2072R, JDBH-2072R & GLBH-2072R PARTS VIEW

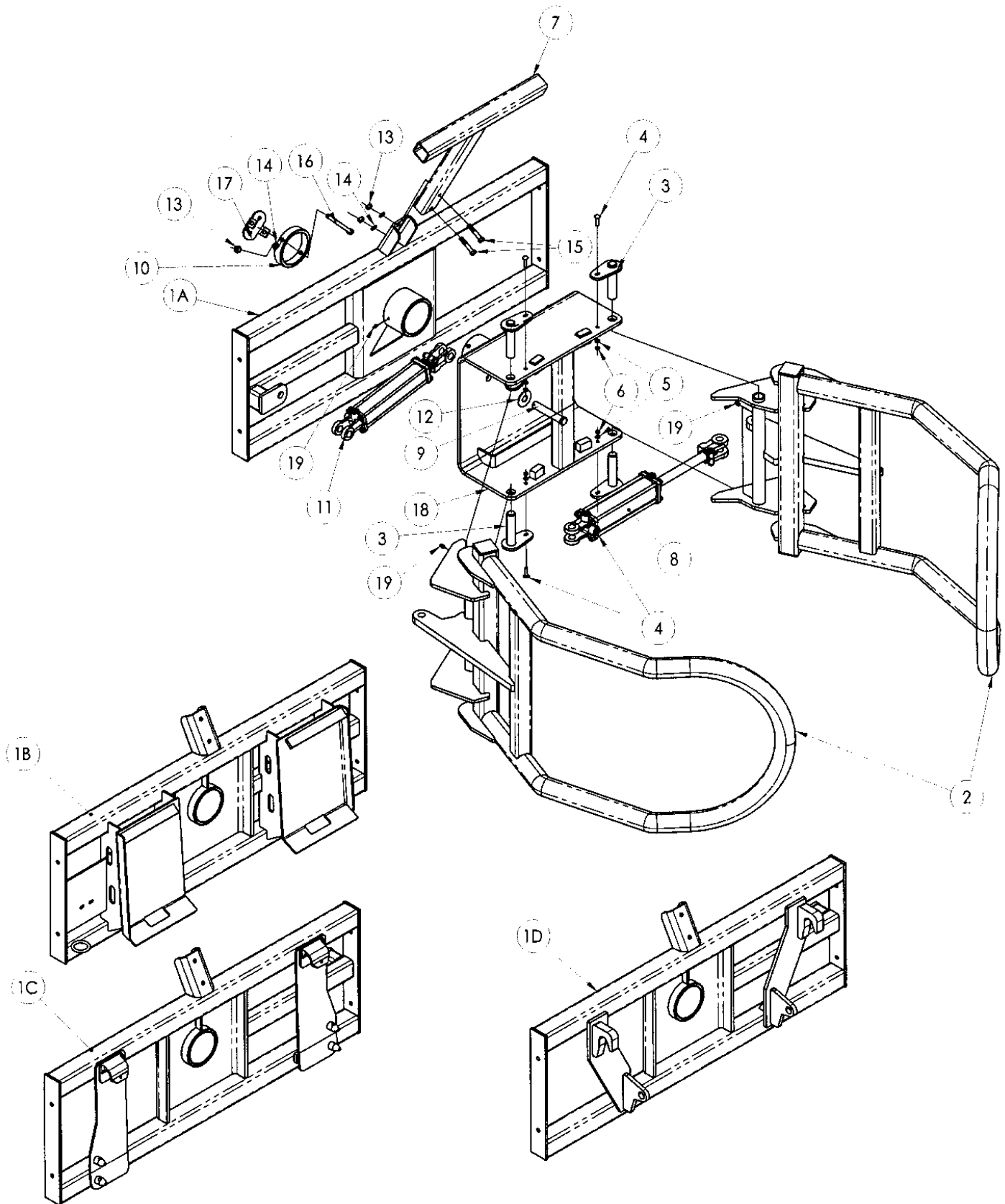

## SSBH-2072R, JDBH-2072R & GLBH-2072R PARTS LIST

Ref. No.	Part No.	Description	No. Req'd.
1A	832993	Main Frame Weldment (UBH-2072R)	1
1B	832979	Main Frame Weldment (SSBH-2072R)	1
1C	832977	Main Frame Weldment (JDBH-2072R)	1
1D	832978	Main Frame Weldment (GLBH-2072R)	1
2	832970	Arm Weldment	2
3	832857	Pivot Pin Weldment	4
4	2503103	Bolt 3/8"-16NC x 1 1/2" Carriage Head Gr. 2	4
5	2502008	Washer 3/8" Springlock	4
6	2500004	Nut 3/8"-16NC Full Hex	4
7	834198	Backstop Weldment	1
8	2504259	Hydraulic Cylinder 3 x 10	1
9	832989	Pin, Cylinder Mount	1
10	832987	Collar, Spindle Lock	1
11	2504265	Hydraulic Cylinder 2 1/2 x 10	1
12	2501014	Washer 1" Medium Flat SAE	1
13	2500003	Nut 1/2"-13NC Full Hex	3
14	2502002	Washer 1/2" Springlock	3
15	2503012	Bolt 1/2"-13NC x 3" Hex Head Gr. 2	2
16	2503364	Bolt 1/2"-13NC x 7" Hex Head Gr. 5	1
17	832378	Bulkhead Panel, Rotating BH	1
18	832994	Frame, Rotating Head	1
19	2504049	Grease Zerk 5/16" Drive	6

# HYDRAULIC DIAGRAM FOR NON-ROTATING BALE HAND MODELS

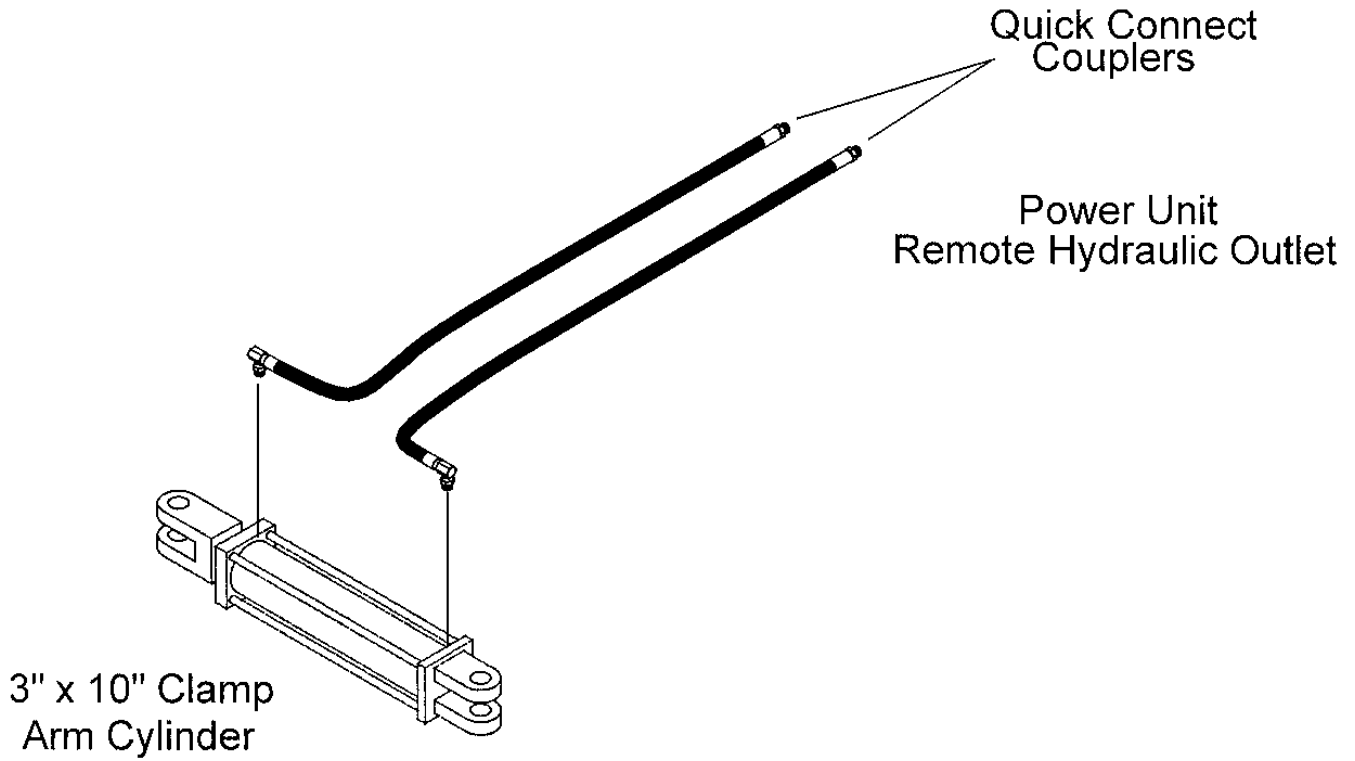

**NOTE: For this model, hoses and fittings are supplied by the customer.**

# PARTS DRAWING & LIST FOR ROTATING BALE HAND MODELS

**DIAGRAM FOR HYDRAULIC CONNECTION FOR POWER UNITS  
EQUIPPED WITH 2 PAIR REMOTE HYDRAULIC OUTLETS**

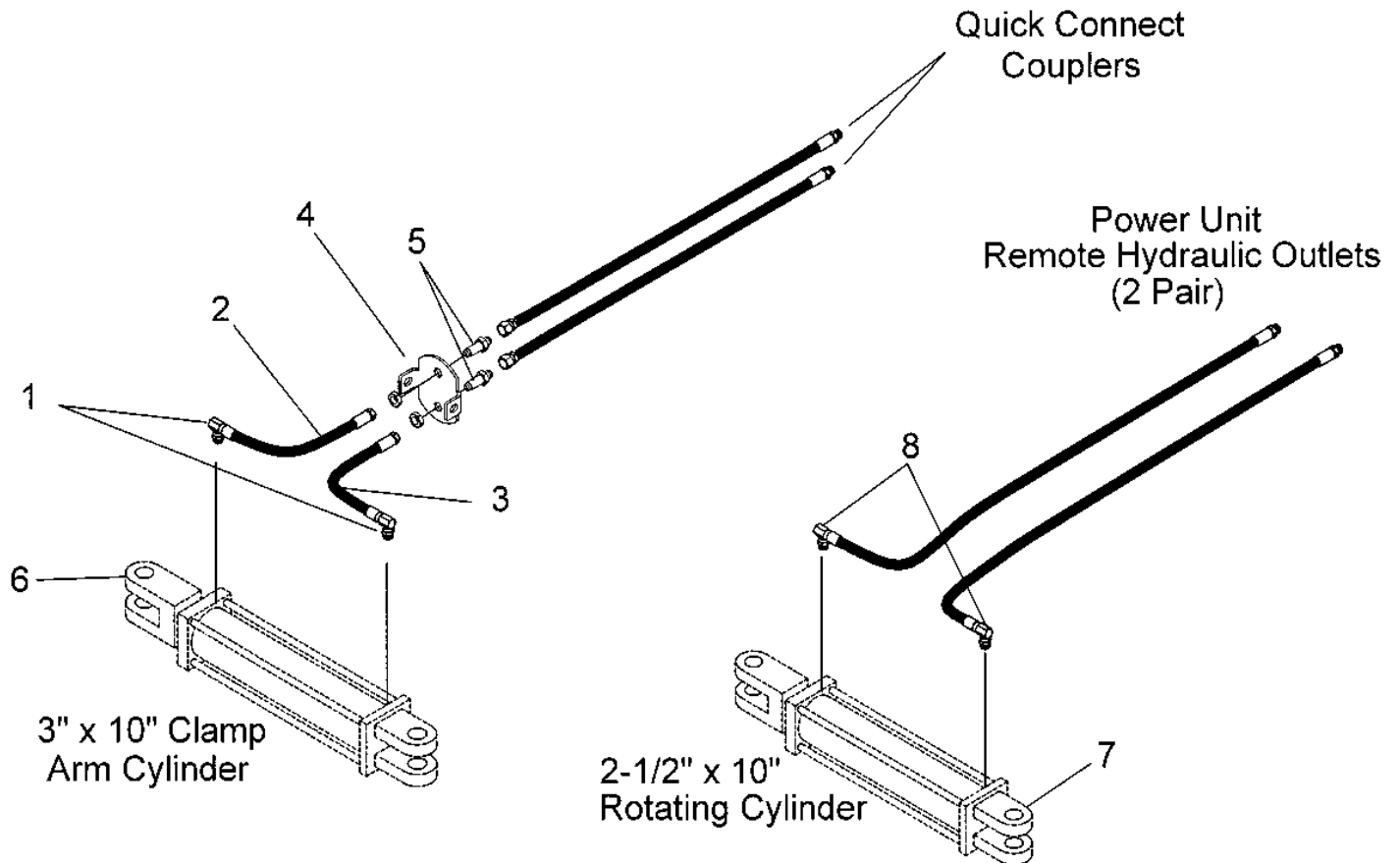

Ref. No.	Part No.	Description	No. Req'd.
1	2505681	90° Swivel Elbow 9/16"-18 to 3/4"-16	2
2	2505801	Hydraulic Hose 1/4" x 21"	1
3	2505802	Hydraulic Hose 1/4" x 25"	1
4	832378	Bulkhead Panel, Rotating Bale Hand	1
5	2505799	Bulkhead Union - 9/16"-18 to 9/16"-18	2
6	2504259	Hydraulic Cylinder 3 x 10	1
7	2504265	Hydraulic Cylinder 2 1/2 x 10	1
8	2505751	90° Swivel Elbow 9/16"-18 to 3/4"-16 w/Orifice	2
N/S	2505544	Tie Wrap	10

# PARTS DRAWING & LIST FOR ROTATING BALE HAND MODELS

**DIAGRAM FOR HYDRAULIC CONNECTION FOR POWER UNITS  
EQUIPPED WITH ONLY 1 PAIR REMOTE HYDRAULIC OUTLETS  
(MOST SKID STEERS)**

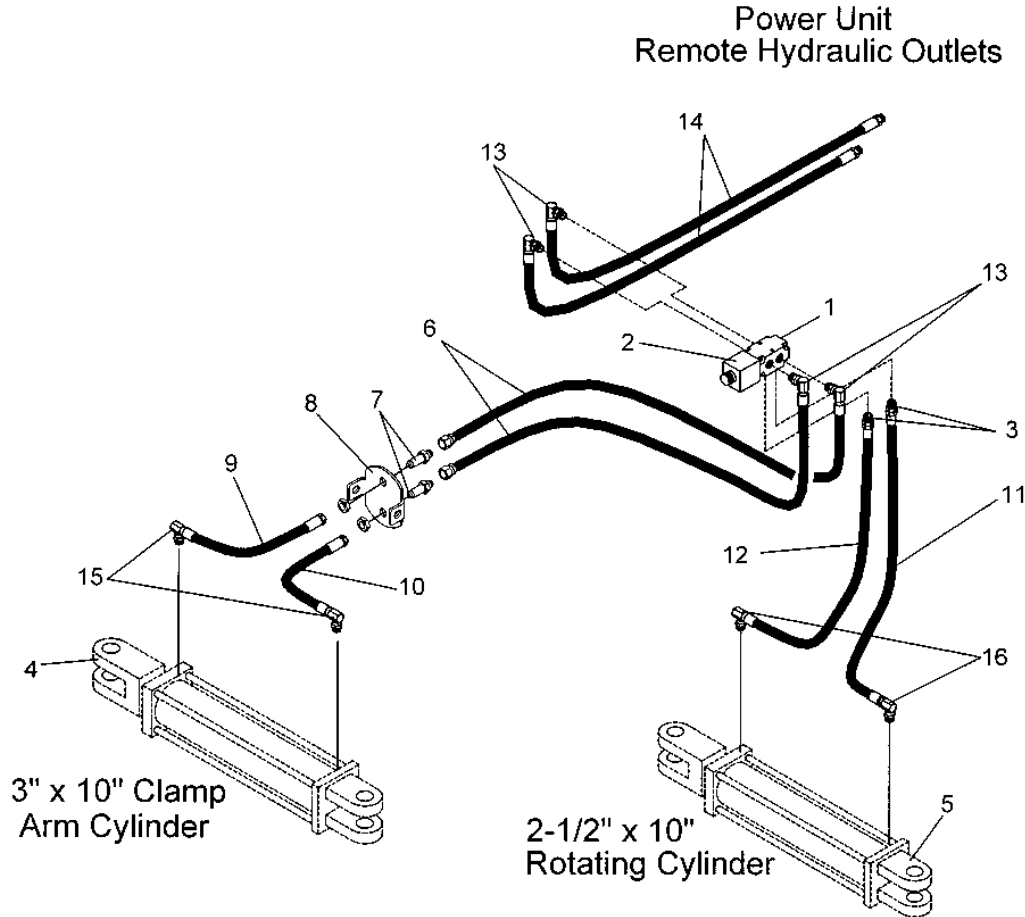

Ref. No.	Part No.	Description	No. Req'd.
1	2505636	Valve Assembly (Includes Item #2)	1
2	2505637	Coil Only	1
3	2505684	Straight Connector - 9/16"-18 to 3/4"-16	2
4	2504259	Hydraulic Cylinder 3 x 10	1
5	2504265	Hydraulic Cylinder 2 1/2 x 10	1
6	2505803	Hydraulic Hose 1/4" x 31"	2
7	2505799	Bulkhead Union - 9/16"-18 to 9/16"-18	2
8	832378	Bulkhead Panel, Rotating Bale Hand	1
9	2505801	Hydraulic Hose 1/4" x 21"	1
10	2505802	Hydraulic Hose 1/4" x 25"	1
11	2505805	Hydraulic Hose 1/4" x 79"	1
12	2505804	Hydraulic Hose 1/4" x 54"	1
13	2505697	90° Swivel Elbow 9/16"-18 to 7/8"-14 ORBM	4
14	2505679	Hydraulic Hose 1/4" x 84"	2
15	2505681	90° Swivel Elbow 9/16"-18 to 3/4"-16	2
16	2505751	90° Swivel Elbow 9/16"-18 to 3/4"-16 w/Orifice	2
N/S	2505544	Tie Wrap	10



# SAFETY REQUIREMENTS

AVOID ACCIDENTS BY FOLLOWING ALL OF THE SAFETY REQUIREMENTS LISTED BELOW.

- Machinery should be operated only by those who are responsible and are authorized to do so.
- Stop the engine, lower all equipment, lock the brakes, and remove the ignition key before dismounting from the tractor.
- Never stand between tractor and implement while tractor is being backed to hitch.
- Loose fitting clothing should not be worn, to avoid catching on various parts.
- Detach implement in area where children normally do not play.
- When performing adjustments or maintenance on an implement, first lower it to the ground or block it securely at a workable height.
- Only a qualified operator should be permitted on tractor when in operation; no riders allowed.
- Make certain everyone is in the clear before starting tractor or raising or lowering equipment.
- Operate the tractor and implement only while seated in the driver's seat.
- Reduce speed when transporting mounted implements to avoid bouncing and momentary loss of steering control.
- A heavy load can cause instability of the tractor. Use extreme care during road travel. Slow down on turns and watch out for bumps. Tractor may need front counterweights to counter-balance the weight of the implement.
- Reduce speed on hillsides or curves so there is no danger of tipping.
- Avoid driving too close to the edge of ditches or creeks.
- Do not transport implement on public roads without reflectors and slow moving vehicle emblem in daylight and with approved warning lights at night and other periods of poor visibility.
- Due to the width of some implements, use extra caution on highways, farm roads, and when approaching gates.
- Always be sure the implement is in the proper position for transport.
- Keep alert and watch the front as well as the rear when working with the implement.

OWNER'S/  
OPERATOR'S  
MANUAL

MODEL NO.'s

UBH-2072

SSBH-2072

GLBH-2072

UBH-2072R

SSBH-2072R

JDBH-2072R

GLBH-2072R

JUNE 2018

*Please work, drive, play and live each day with care and concern for your safety and that of your family and fellow citizens.*

## BALE HAND & ROTATING BALE HAND

WHEN ORDERING REPAIR PARTS,  
ALWAYS GIVE THE FOLLOWING INFORMATION:

1. PART NUMBER
2. PART DESCRIPTION
3. MODEL NUMBER
4. NAME OF ITEM

Please work, drive, play, and live each day with care and concern for your safety and that of your family and fellow citizens.

**WORKSAVER, INC.**

P.O. BOX 100 LITCHFIELD, IL 62056-0100 (217) 324-5973  
WEB: <http://www.worksaver.com> E-MAIL: [sales@worksaver.com](mailto:sales@worksaver.com)