

SAFETY REQUIREMENTS

AVOID ACCIDENTS BY FOLLOWING ALL OF THE SAFETY REQUIREMENTS LISTED BELOW.

- Machinery should be operated only by those who are responsible and are authorized to do so.
- Stop the engine, lower all equipment, lock the brakes, and remove the ignition key before dismounting from the tractor.
- Never stand between tractor and implement while tractor is being backed to hitch.
- Loose fitting clothing should not be worn, to avoid catching on various parts.
- Detach implement in area where children normally do not play.
- When performing adjustments or maintenance on an implement, first lower it to the ground or block it securely at a workable height.
- Only a qualified operator should be permitted on tractor when in operation; no riders allowed.
- Make certain everyone is in the clear before starting tractor or raising or lowering equipment.
- Operate the tractor and implement only while seated in the driver's seat.
- Reduce speed when transporting mounted implements to avoid bouncing and momentary loss of steering control.
- A heavy load can cause instability of the tractor. Use extreme care during road travel. Slow down on turns and watch out for bumps. Tractor may need front counterweights to counter-balance the weight of the implement.
- Reduce speed on hillsides or curves so there is no danger of tipping.
- Avoid driving too close to the edge of ditches or creeks.
- Do not transport implement on public roads without reflectors and slow moving vehicle emblem in daylight and with approved warning lights at night and other periods of poor visibility.
- Due to the width of some implements, use extra caution on highways, farm roads, and when approaching gates.
- Always be sure the implement is in the proper position for transport.
- Keep alert and watch the front as well as the rear when working with the implement.

OWNER'S/
OPERATOR'S
MANUAL

MODEL NO.'s
BBSF-20
CBSF-2000
CBSF-2028
CBSF-3028

WHEN ORDERING REPAIR
PARTS, ALWAYS GIVE THE
FOLLOWING INFORMATION:

1. PART NUMBER
2. PART DESCRIPTION
3. MODEL NUMBER
4. NAME OF ITEM

MAY 2013

MAKE EVERY DAY
A HOLIDAY FROM ACCIDENTS

LOADER BUCKET SPEAR ATTACHMENT(S) (BOLT-ON and CLAMP-ON)

LIMITED WARRANTY

Worksaver warrants its implements, parts and accessories to be free from defects in materials and workmanship for a period of six (6) months from date of purchase. Upon written approval, Worksaver will repair or exchange without charge any part, which upon examination by Worksaver or its authorized agent, shall disclose to be defective.

This does not apply to (1) parts that have worn out in normal use, (2) parts broken because of improper assembly or operation by the customer, (3) parts accidentally damaged, (4) failure of parts traceable to improper care, (5) parts failing through use of implement for purposes other than those for which it was designed.

The obligations assumed by Worksaver and the limitations expressed herein are in lieu of all other warranties expressed or implied.

WORKSAVER, INC.

P.O. BOX 100 LITCHFIELD, IL 62056-0100 (217) 324-5973
WEB: <http://www.worksaver.com> E-MAIL: sales@worksaver.com

OWNER'S/
OPERATOR'S
MANUAL

MODEL NO.'s
BBSF-20
CBSF-2000
CBSF-2028
CBSF-3028

CAUTION

For Safe Operation
Read Rules And
Instructions Carefully

SI NO LEEINGLES, PIDA AYUDA
A AIGUIEN QUE SI LO LEA
PARA QUE LE TRADUZCA LAS
MEDIDAS DE SEGURIDAD.

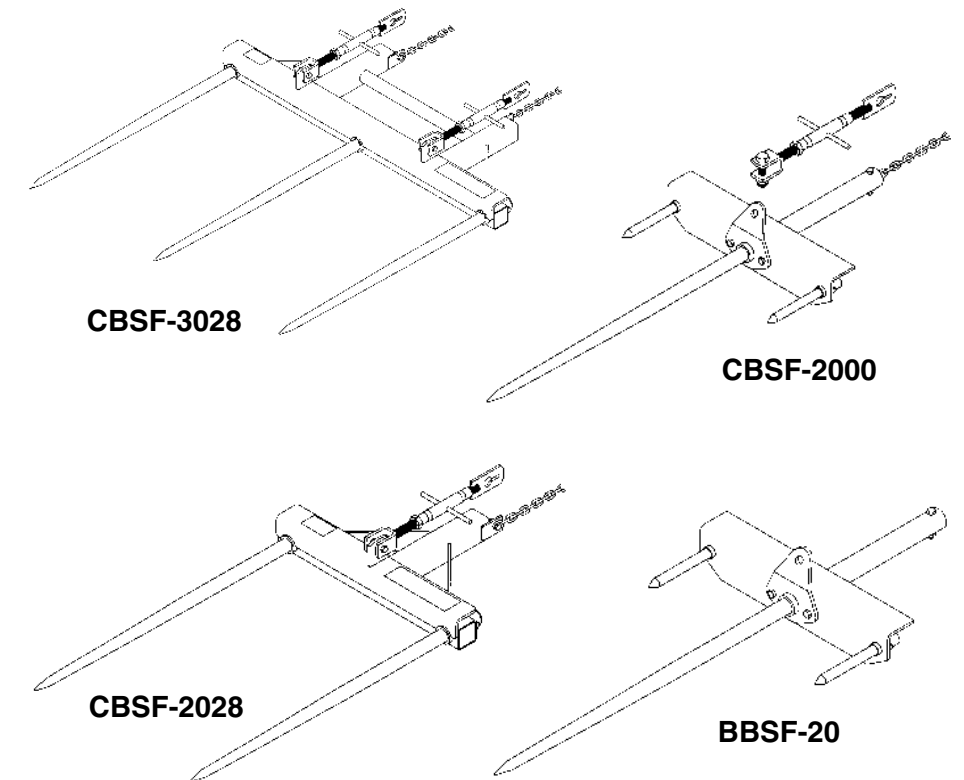

CBSF-3028

CBSF-2000

CBSF-2028

BBSF-20

LOADER BUCKET SPEAR ATTACHMENT(S) (BOLT-ON and CLAMP-ON)

Safety Instructions
ATV/Tractor Preparation
Operating Instructions

Assembly & Mounting
Maintenance
Repair Parts

CAUTION

THE FOLLOWING SAFETY PRECAUTIONS SHOULD BE THOROUGHLY UNDERSTOOD
BEFORE ATTEMPTING TO BEGIN ASSEMBLING THIS MACHINE

1. Select an area for assembly that is clean and free of any debris which might cause persons working on the assembly to trip.
2. Do not lift heavy parts or assemblies. Use crane, jack, tackle, fork trucks or other mechanical devices.
3. Preview the assembly instructions in your operator's manual before proceeding further.
4. If the assembly instructions call for parts or assemblies to be blocked up, use only blocking material that is in good condition and is capable of handling the weight of the assembly to be blocked. Also insure that the blocking material is on a clean, dry surface.
5. Never put hands, or any part of body, under blocked up assemblies if at all possible.
6. After completing assembly, thoroughly inspect the machine to be sure that all nuts, bolts, hydraulic fittings or any other fastened assemblies have been thoroughly tightened.
7. Before operating the machine, thoroughly read the operation section of your operator's manual.
8. Before operating, read the maintenance section of your operator's manual to be sure that any parts requiring lubrication, such as gearboxes, are full, to avoid any possible damage.
9. Before operating equipment – If you have any questions regarding the proper assembly or operation, contact your dealer or representative.

To the Owner/Operator/Dealer

All implements with moving parts are potentially hazardous. There is no substitute for a cautious, safe-minded operator who recognizes the potential hazards and follows reasonable safety practices. The manufacturer has designed this implement to be used with all its safety equipment properly attached to minimize the chance of accidents.

BEFORE YOU START!!

Read the safety messages on the implement and shown in your manual.
Observe the rules of safety and common sense!



THIS SYMBOL MEANS

- ATTENTION!
- BECOME ALERT!
- YOUR SAFETY IS INVOLVED!

THIS SAFETY ALERT SYMBOL IDENTIFIES IMPORTANT SAFETY WARNING MESSAGES. CAREFULLY READ EACH WARNING MESSAGE THAT FOLLOWS. FAILURE TO UNDERSTAND AND OBEY A SAFETY WARNING, OR RECOGNIZE A SAFETY HAZARD, COULD RESULT IN AN INJURY OR DEATH TO YOU OR OTHERS AROUND YOU. THE OPERATOR IS ULTIMATELY RESPONSIBLE FOR THE SAFETY OF HIMSELF, AS WELL AS OTHERS, IN THE OPERATING AREA OF THE TRACTOR AND EQUIPMENT.

UNDERSTAND SIGNAL WORDS

! DANGER Indicates an imminently hazardous situation that, if not avoided, WILL result in DEATH OR VERY SERIOUS INJURY.

! WARNING Indicates a imminently hazardous situation that, if not avoided, COULD result in DEATH OR SERIOUS INJURY.

! CAUTION Indicates a imminently hazardous situation that, if not avoided, MAY result in MINOR INJURY.

IMPORTANT Identifies special instructions or procedures that, if not strictly observed, could result in damage to, or destruction of the machine, attachments or the environment.

NOTE: Identifies points of particular interest for more efficient and convenient operation or repair.

If you have questions not answered in this manual or require additional copies or the manual is damaged, please contact your dealer or the manufacturer directly.

Important Safety Information!

Working with equipment can lead to injuries. Read this manual, and the manual for your tractor, before assembly or operating, to acquaint yourself with the machine. It is the equipment owner's responsibility, if this equipment is used by any person other than yourself, is loaned or rented, to make certain that the operator, prior to operating:

1. Reads and understands the operator's manuals.
2. Is instructed in safe and proper use.

! The use of this equipment is subject to certain hazards which cannot be protected against by mechanical means or product design. All operators of this equipment must read and understand this entire manual, paying particular attention to safety and operating instructions, prior to using. If there is something in this manual you do not understand, ask your supervisor, or your dealer, to explain it to you.

CBSF-2028 PARTS LIST

Ref. No.	Part No.	Description	No. Req'd.
1	831925	Main Frame Weldment	1
2	830928	Spear, Bolt-In (47 1/4" Lg.)	2
3	2503012	Bolt 1/2"-13NC x 3" Hex Head Grade 2	2
4	2502002	Washer 1/2" Springlock	2
5	2500003	Nut 1/2"-13NC Full Hex	2
	831195	Complete Turnbuckle Assembly (#6 thru #10)	1
6	590277	Barrel	1
7	830412	Threaded Stub, LH	1
8	831196	Threaded Stub, RH	1
9	2500024	Nut 1"-8NC Jam Hex	1
10	590145	Handle	1
11	2503265	Bolt 1/2"-13NC x 1 3/4" Hex Head Grade 5	1
12	2501003	Washer 1/2" Flat	1
13	2500039	Nut 1/2"-13NC Hex Nylock	1
14	830406	Chain, 5/16" Proof Coil x 5 Ft.	1
15	2503024	Bolt 3/4"-10NC x 3 1/2" Hex Head Grade 2	1
16	2500037	Nut 3/4"-10NC Hex Nylock	1
17	101277	Safety Sign - Warning (Read Manual)	1
18	101127	Safety Sign - Warning (Insert Spears)	1

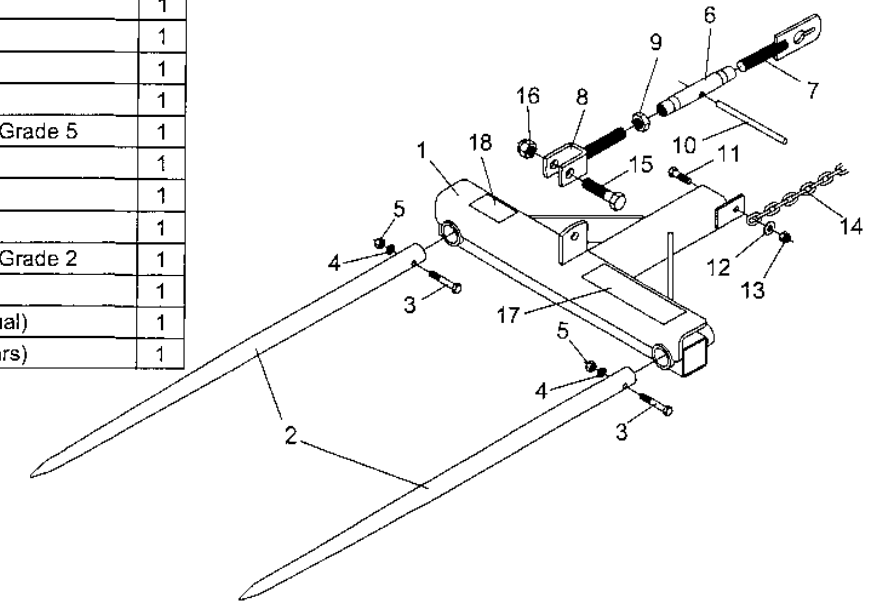

CBSF-3028 PARTS LIST

Ref. No.	Part No.	Description	No. Req'd.
1	831956	Main Frame Weldment	1
2	830928	Spear, Bolt-In (47 1/4" Lg.)	3
3	2503012	Bolt 1/2"-13NC x 3" Hex Head Grade 2	3
4	2502002	Washer 1/2" Springlock	3
5	2500003	Nut 1/2"-13NC Full Hex	3
	831195	Complete Turnbuckle Assembly (#6 thru #10)	2
6	590277	Barrel	2
7	830412	Threaded Stub, LH	2
8	831196	Threaded Stub, RH	2
9	2500024	Nut 1"-8NC Jam Hex	2
10	590145	Handle	2
11	2503265	Bolt 1/2"-13NC x 1 3/4" Hex Head Grade 5	2
12	2501003	Washer 1/2" Flat	2
13	2500039	Nut 1/2"-13NC Hex Nylock	2
14	830406	Chain, 5/16" Proof Coil x 5 Ft.	2
15	2503024	Bolt 3/4"-10NC x 3 1/2" Hex Head Grade 2	2
16	2500037	Nut 3/4"-10NC Hex Nylock	2
17	101277	Safety Sign - Warning (Read Manual)	1
18	101127	Safety Sign - Warning (Insert Spears)	1

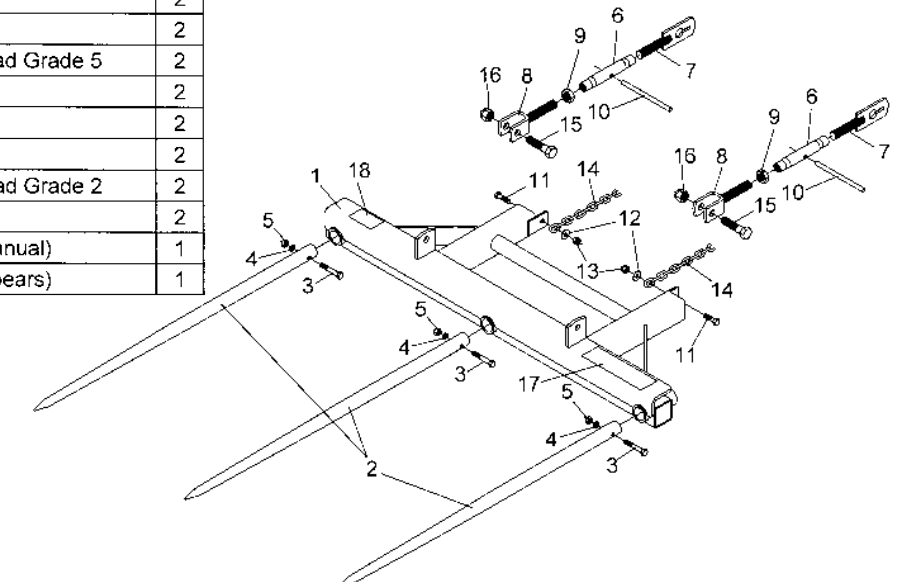

Ref. No.	Part No.	Description	No. Req'd.
1	830181	Bucket Angle Weldment	1
2	830186	Tube/Flange Weldment	1
3	830928	Spear, Bolt-In (47 1/4" Lg.)	1
4	830213	Spike, Balance (1" Dia. x 10 13/16" Lg.)	2
5	2503145	Bolt 1/2"-13NC x 1 1/2" Hex Head Grade 5	2
6	2503012	Bolt 1/2"-13NC x 3" Hex Head Grade 2	1
7	2502002	Washer 1/2" Springlock	4
8	2500003	Nut 1/2"-13NC Full Hex	4
9	2503120	Bolt 3/8"-16NC x 1 3/4" Hex Head Grade 2	2
10	2502008	Washer 3/8" Springlock	2
11	2500004	Nut 3/8"-16NC Full Hex	2
12	2503079	Bolt 1/2"-13NC x 4" Hex Head Grade 2	1
13	101277	Safety Sign - Warning (Read Manual)	1

BBSF-20 PARTS LIST

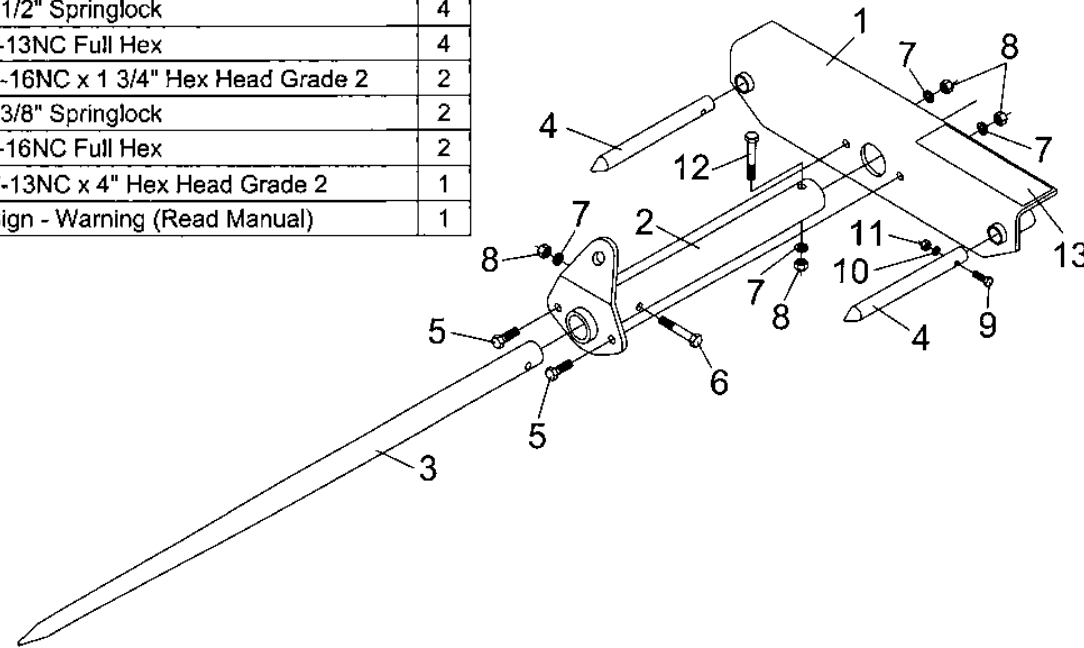

Ref. No.	Part No.	Description	No. Req'd.
1	830181	Bucket Angle Weldment	1
2	830186	Tube/Flange Weldment	1
3	830928	Spear, Bolt-In (47 1/4" Lg.)	1
4	830213	Spike, Balance (1" Dia. x 10 13/16" Lg.)	2
5	2503145	Bolt 1/2"-13NC x 1 1/2" Hex Head Grade 5	2
6	2503012	Bolt 1/2"-13NC x 3" Hex Head Grade 2	1
7	2502002	Washer 1/2" Springlock	4
8	2500003	Nut 1/2"-13NC Full Hex	4
9	2503120	Bolt 3/8"-16NC x 1 3/4" Hex Head Grade 2	2
10	2502008	Washer 3/8" Springlock	2
11	2500004	Nut 3/8"-16NC Full Hex	2
12	2503079	Bolt 1/2"-13NC x 4" Hex Head Grade 2	1
	831195	Turnbuckle Assembly (Items #13 thru #17)	1
13	590277	Barrel	1
14	830412	Threaded Stub - LH	1
15	831196	Threaded Stub - RH	1
16	2500024	Nut 1"-8NC Hex Jam	1
17	590145	Handle	1
18	830406	Chain, 5/16" Proof Coil x 5 Ft.	1
19	2503024	Bolt 3/4"-10NC x 3 1/2" Hex Head Grade 2	1
20	2500037	Nut 3/4"-10NC Hex Nylock	1
21	101277	Safety Sign - Warning (Read Manual)	1

CBSF-2000 PARTS LIST

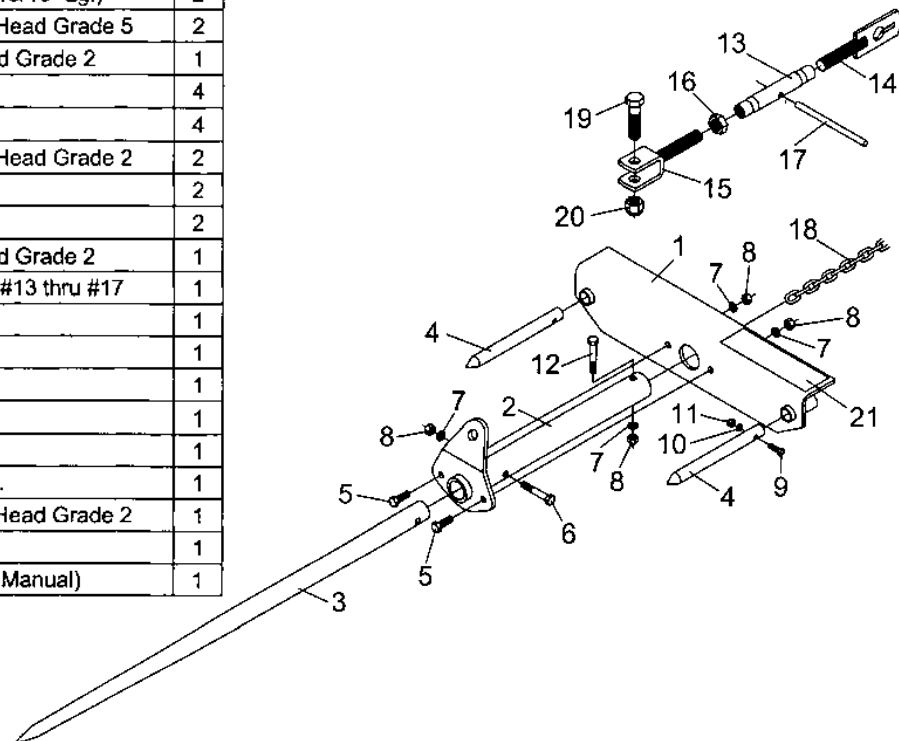















SAFETY INSTRUCTIONS (continued)

- ⚠ Keep all helpers and bystanders fifty feet (50') from operating equipment. Only properly trained people should operate this tractor and attached implement. It is recommended the tractor be equipped with a Rollover Protection System (ROPS) and a seat belt that is used. Always stop the tractor, set brake, shut off the tractor engine, remove the tractor key, and lower implement to the ground before dismounting tractor. Never leave equipment unattended with the tractor running.
- ⚠ All equipment is potentially hazardous. There is no substitute for a cautious, safe-minded operator who recognizes potential hazards and follows reasonable safety practices.
- ⚠ Start tractor only when properly seated in the tractor seat. Starting a tractor in gear can result in injury or death. Do not mount or dismount the tractor while the tractor is moving. Mount or dismount the tractor only when the tractor and all moving parts are completely stopped.
- ⚠ Operate the tractor and/or implement controls only while properly seated in the tractor seat with the seat belt securely fastened around you. Inadvertent movement of the tractor or implement may cause serious injury or death.
- ⚠ Be particularly careful when transporting the implement with the tractor. Turn curves or go up hills only at a low speed and using a gradual steering angle. Rear mounted implements move the center of gravity to the rear and remove weight from the front wheels. Make certain, by adding front ballast, that at least 20% of the tractor's weight is on the front wheels to prevent rearing up, loss of steering control or tractor tip-over. Slow down on rough or uneven surfaces to prevent loss of steering control which could result in property damage or possible injury. Do not transport unless 3-point lift lever is fully raised and in the transport position. Dropping implement in transport can cause serious damage to the tractor and/or implement and possibly cause the operator or others to be injured or killed.
- ⚠ BEFORE leaving the tractor seat, lower the implement, set the parking brake and/or set the tractor transmission in parking gear, disengage the PTO, stop the engine, remove the key, and wait for all moving parts to stop. Place the tractor shift lever into a low range or parking gear to prevent the tractor from rolling. Never dismount a tractor that is moving or while the engine is running. Operate the tractor controls from the tractor seat only.
- ⚠ Never leave the tractor and implement unattended while the implement is in the lifted position. Accidental operation of lifting lever or a hydraulic failure may cause sudden drop of unit with injury or death by crushing.
- ⚠ Never use alcoholic beverages or drugs which can hinder alertness or coordination while operating equipment. Consult your doctor about operating tractor and implement while taking prescription medications.
- ⚠ Do not allow children or others to ride on the tractor with an operator. Riders are subject to injury such as being struck by foreign objects or being thrown off. Riders obstruct the operator's view resulting in unsafe operation. **Never allow anyone to ride on the implement!**
- ⚠ Never allow children to play on or around tractor or implement. Children can slip or fall off the equipment and be injured or killed. Inadvertent contact with controls can cause the implement to shift or fall crushing themselves or others.
- ⚠ Do not allow anyone who is not familiar with the safety rules and operation instructions to use this equipment.
- ⚠ Do not exceed lift capacity of the tractor hitch.
- ⚠ Keep alert and watch the rear as well as the front when working with the attached implements.

SAFETY INSTRUCTIONS (continued)



OPERATIONAL SAFETY

-  This equipment is dangerous to children and persons unfamiliar with its operation. The operator should be a responsible adult familiar with farm machinery and trained in this equipment's operations. **Do not allow persons to operate or assemble this unit until they have read this manual and have developed a thorough understanding of the safety precautions and of how it works.**
-  Personal protection equipment including hard hat, safety glasses, safety shoes, and gloves are recommended during assembly, installation, operation, adjustment, maintaining, repairing, removal, or moving the implement. Do not allow long hair, loose fitting clothing or jewelry to be around moving parts.
-  Never permit any person other than the operator to ride or board the tractor or implement at any time. **ALLOW NO RIDERS!**
-  The use of any loader attachment is NOT recommended on tractor with a tricycle wheel arrangement. Tricycle type tractors are unstable for front loader use.
-  A heavy load can cause instability in driving a tractor. Make sure the front or rear of the tractor is properly counter-balanced with weights. Always drive slowly – especially around turns. An unstable tractor could steer badly and possibly tip over, causing injury or death.
-  Most accidents occur because of neglect or carelessness. Keep all helpers and bystanders at a safe distance. **REMEMBER FALLING BALES CAN ROLL OR TUMBLE.**
-  Beware of low electrical wires when loader is raised. Serious injury or death can result if contact is made.
-  Always insert spears into the bale – NEVER under the bale. Failure to insert spears into bale can allow bale to roll back when loader is raised, causing serious injury or death.
-  Do not handle bales that exceed the bale weight limitations of the loader.
-  Carry the bale slowly and as low as possible to the ground. Avoid excessive speed during operation.
-  Operate the loader controls smoothly, avoiding jerky operation.
-  When handling round bales on a slope, always approach the bale with the tractor facing uphill.
-  Never use the tractor/loader to stop a rolling bale.
-  Only use a power unit equipped with a ROPS cab or rollover protective structure. Keep foldable ROPS systems in “locked up” position at all times. Keep seat belt fastened.
-  When stacking bales, **ALWAYS MAKE SURE BALES ARE PLACED SO THE STACK IS STABLE.**

OWNER SERVICE

TRANSPORTING

WARNING

A heavy load can cause instability in driving a tractor. Make sure the rear of the tractor is properly counter-balanced with weights or a bale. Always drive slowly – especially around turns. An unstable tractor could steer badly and possibly tip over, causing injury or death.

CAUTION

When traveling on public roads, whether at night or during the day, use accessory light and devices for adequate warnings to operators of other vehicles. Comply with all federal, state and local laws.

Carry load low.

Check visibility. If visibility is impaired, reduce speed or consider other means of bale transport.

Allow for additional length of loader and attachment on tractor while turning.

When traveling over rough or hilly terrain or when making turns, slow down and use extra care.

Read all the safety warnings in the front of this manual and in the manual of tractor or skid steer unit.

STORAGE

- Inspect the attachment for loose, damaged or worn parts and adjust or replace if needed.
- Sand areas where paint is chipped or worn and repaint to prevent rust.
- Always store in a safe place away from children or livestock.



**SAFETY . . .
YOU CAN LIVE WITH IT!**

MAINTENANCE

WARNING

NEVER GO UNDERNEATH EQUIPMENT. Never place any part of the body underneath equipment or between moveable parts even when the engine has been turned off. Hydraulic system leak down, hydraulic system failures, mechanical failures, or movement of control levers can cause equipment to drop or rotate unexpectedly and cause severe injury or death.

WARNING

- Keep all persons away from operator control area while performing adjustments, service, or maintenance.
- Before dismounting power unit or performing any service or maintenance, follow these steps: disengage power to equipment, lower the 3 point hitch and all raised components to the ground, operate valve levers to release any hydraulic pressure, set parking brake, stop engine, remove key, and unfasten seat belt.

Check the pins at the ends of the loader arms. Make sure they are locked in place.

Periodically check all bolts to make sure they are tight.

Grease threads on turnbuckle.

Lubricate loader as per instructions in loader manual.

Replace safety signs and instruction decals if damaged or missing.

Replace any worn or damaged parts immediately. Do not use attachment with any damaged parts.

INSTRUCTIONS (continued)

HANDLE BALES SAFELY

Improper use of loaders to handle bales can result in serious injury or death to the operator. This could be caused by the bale tumbling back down the loader into the operator's station.

For optimum stability and visibility:

- Become familiar with controls.
- Be sure anyone operating the loader is aware of safe operation and potential hazards. Read and observe safety recommendations in loader manual.
- Operate loader from operator's seat only. Remain at controls until operating cycle is complete.
- Do not handle bales that exceed the bale weight limitations of the loader.
- Carry the bale slowly and as low as possible to the ground.
- Operate the loader hydraulic controls smoothly, avoiding jerky operation.
- When handling round bales on a slope, always approach the bale with the power unit facing uphill.
- Never use the tractor/loader to stop a rolling bale.
- Only use a tractor or power unit equipped with a ROPS cab or roll-over protective structure.
- Stop loader gradually when lowering or lifting loads.
- Use particular care when working on inclines and hill-sides.
- Avoid holes, ditches, and obstructions which may cause tractor/loader to tip.
- Allow for additional length of loader on tractor while turning.
- Never allow anyone to walk or work under a raised loader.
- Be sure that people, livestock, or pets are not standing near the machine while operating.
- Do not use the loader for a work platform.
- Do not lift or carry anyone on loader or in bucket or attachment.

- Travel slowly over rough ground or when making turns.
- Drive slowly through gates and doors.
- Avoid carrying loose or shiftable loads.
- Lower bucket or attachment to ground when loader is unattended.

CAUTION

NEVER LET ANYONE CLIMB ON STACKED ROUND HAY BALES!

WARNING

Do not work under a raised loader unless it is securely blocked or held in position. Do not depend on the hydraulic system to hold loader and attachment in place.

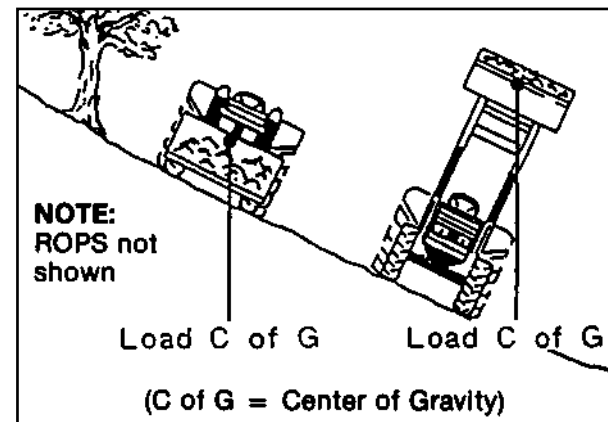















When working on side hills, **DO NOT RAISE LOADER TOO HIGH.** Keep an eye on terrain changes. Keep load low.

 **ALWAYS OBEY ALL SAFETY RULES!**
ALWAYS BE CAREFUL!

SAFETY INSTRUCTIONS (continued)



OPERATIONAL SAFETY (continued)

-  For operator safety, always keep bale in front of tractor hood. NEVER position bale back over operator. ALWAYS BE CAREFUL!
-  Always load rear of tractor first and unload last when using a front loader.
-  Beware of lift clearance when raising loader to maximum height.
-  When maneuvering close to buildings or passing through narrow areas, be sure to allow sufficient clearance for the tractor, loader, and bale. Drive slowly.
-  Operate loader from operator's seat only. Remain at controls until operating cycle is complete.
-  Stop loader gradually when lowering or lifting loads.
-  Allow for additional length of loader and bale on tractor while turning.
-  Never allow anyone to walk or work under a raised loader.
-  Be sure that people, livestock, or pets are not standing near the machine while operating.
-  Do not use loader for a work platform.
-  Do not lift or carry anyone on loader or in bucket or on attachment.
-  ALWAYS lower loader to the ground or block securely before performing any maintenance work.
-  Stay alert for holes, rocks and roots in the terrain and other hidden hazards. Keep away from drop-offs.
-  Use extreme care and maintain minimum ground speed when transporting on hillside, over rough ground and when operating close to ditches or fences. Be careful when turning sharp corners.
-  Reduce speed on slopes and sharp turns to minimize tipping or loss of control. Be careful when changing directions on slopes. Do not start or stop suddenly on slopes. Avoid operation on steep slopes.

SAFETY INSTRUCTIONS (continued)











OPERATIONAL SAFETY (continued)

-  ALWAYS lower spear points to the ground when parking tractor. Raised spear points could cause injury to people or livestock.
-  Always shut off tractor and shift to “Park” or set brakes when leaving tractor. Always lower bucket or attachment to ground. Remove key when leaving tractor unattended.





TRANSPORT SAFETY

-  Comply with state and local laws governing highway safety and movement of farm machinery on public roads.
-  The use of flashing amber lights is acceptable in most localities. However, some localities prohibit their use. Local laws should be checked for all highway lighting and marking requirements.
-  When driving the tractor and equipment on the road or highway under 20 mph (32 kph) at night or during the day, use flashing amber warning lights and a slow moving vehicle (SMV) identification emblem.
-  Always be sure the implement is in the proper raised position for transport.
-  Reduce speed when transporting mounted implements to avoid bouncing and momentary loss of steering control.
-  Make sure large round bales transported on tractor rear 3 pt. hitch do not obstruct visibility of tractor’s flashing lights or SMV sign.
-  When transporting large round bales, keep load as low as practical to maximize tractor stability.
-  Transporting large round bales on front loaders can limit visibility. Keep load low and go slow if visibility is obstructed. Always use extra care.
-  Turn curves or go up or down hills only at a low speed and at a gradual steering angle. Make certain that at least 20% of the tractor’s weight is on the front wheels to maintain safe steering. Slow down on rough or uneven surfaces, and loose gravel.



MAINTENANCE SAFETY

-  Keep all persons away from operator control area while performing adjustments, service, or maintenance.
-  Before working on this machine, drive to a level area, disengage the PTO, lower implement (or if working underneath, raise and block securely), shut off the engine, set the brakes, and remove the ignition keys.
-  Never work under equipment unless it is blocked securely. Never depend on hydraulic system to keep implement in raised position.

INSTRUCTIONS (continued)

OPERATION

The operator is responsible for the safe operation of this equipment. The operator must be properly trained. Operators should be familiar with the attachment, tractor, and loader and all safety practices before starting operation.

Make sure all operators have read the Owner’s/Operator’s Manual and are familiar with the instructions and the safety rules of operation.

Be sure tractor is properly counter-balanced with weights before attempting to lift any load with the Bale Spear or Forklift Attachment.

If you are handling bales with both the front end loader and the 3 pt. hitch on the tractor, always load the 3 pt. attachment first and unload last.

Using the bucket tilt cylinders, adjust the angle of the spear(s) so they are parallel with the center of the hay bale.

With the tractor, push the spear(s) into the large hay bale. Make sure you have penetrated the hay bale far enough so the bale doesn’t want to come off the end of the spear(s). If, when you initially pick the bale up, it tends to droop forward, this would indicate you have not penetrated the bale far enough.

Tilt the ends of the spear(s) upward (about 15-20 degrees) when transporting the hay bales. This will reduce any tendency for the bale to slide off the spear(s) while being transported.

When you have placed the hay bale in the desired location, it is recommended to tilt the spear ends slightly downward (5-7 degrees) so as you pull away from the bale it will slide off the spear(s) more easily. Different location and circumstances will determine the best withdraw angle to use.

NOTE: Always make sure bale spear fully penetrates the bale. Partial penetration locates all the weight of the bale on the outer end and can damage spear. Not covered under warranty.

NOTE: In cold weather, a bale frozen to the ground may exceed the lifting capacity of spear and loader. Damage to spear or loader may occur. Not covered under warranty.

NOTE: Soft center bales will tend to droop after being lifted by a single spear. Placing the spear in a lower position in the bale will allow for more lifting height and lessen the load on the stabilizer spears.



WARNING

On multiple spear models CBSF-2028 and CBSF-3028, always insert spears into the bale – NEVER under the bale. Failure to insert spears into bale can allow bale to roll back when loader is raised, causing serious injury or death.



WARNING

- Never exceed the lift capacity of the tractor-loader used with the spear attachment.
- Beware of lift clearance when raising loader to maximum height.
- When stacking hay bales or loading vehicles, make sure you are operating in an area AWAY FROM OVERHEAD WIRES.
- For operator safety, always keep bales in front of tractor hood. NEVER position bale back over operator. ALWAYS BE CAREFUL!



DANGER

Beware of low electrical wires when loader is raised. Serious injury or death can result if contact is made.

When stacking bales, ALWAYS MAKE SURE BALES ARE PLACED SO THE STACK IS STABLE.

Keep all bystanders at a safe distance. REMEMBER – FALLING BALES CAN ROLL OR TUMBLE.

Safety is a primary concern in the design and manufacture of our products. Unfortunately, our efforts to provide safe equipment can be wiped out by an operator’s single careless act.

In addition to the design and configuration of equipment, hazard control and accident prevention are dependent upon the awareness, concern, judgment, and proper training of personnel involved in the operation, transport, maintenance and storage of equipment.

It has been said, “The best safety device is an informed, careful operator.” We ask you to be that kind of an operator.

INSTRUCTIONS (continued)

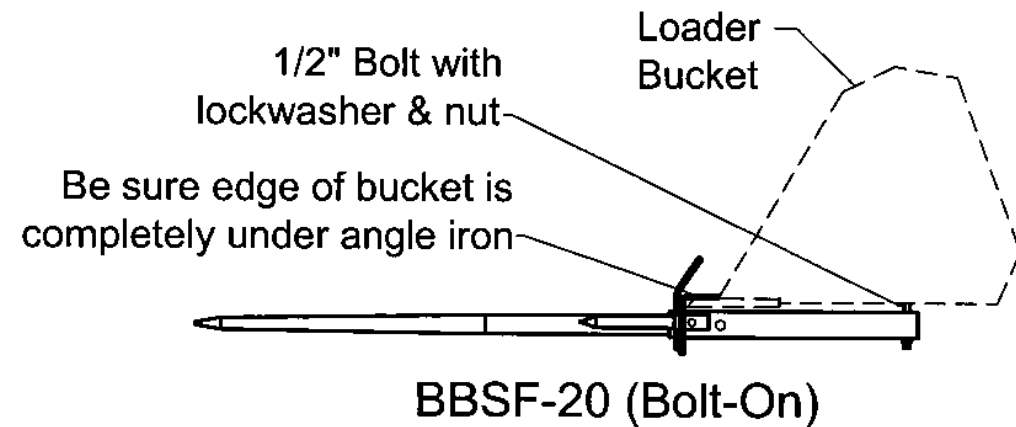

ASSEMBLY – BBSF-20 (BOLT-ON)

Check your loader to make sure it is in good working order.

Refer to the exploded parts view of the BBSF-20 on page 13. Slide the tube through the hole in the formed angle and align the bolt holes. Install the two 1/2" x 1 1/2" bolts and tighten. Insert the spear and align the horizontal hole in the tube with the hole in the spear. Insert the 1/2" x 3" bolt and tighten.

Refer to the line drawing above for proper orientation of the Bale Spear attachment and the bolt, washer, and nut. Slide the front cutting edge of your loader bucket under the angle iron lip of the bucket attachment.

Raise the loader slightly so that the bottom of the attachment is about two or three feet off the ground and tilt the bucket all the way back for easier access to the bottom of the loader bucket. Engage tractor parking brake and shut off the engine.

Place some solid blocking under the bottom of the loader bucket for safety.

Mark the location for the hole required to bolt on the loader spear.

Remove the attachment and drill a 17/32" dia. hole in the bottom of your loader bucket at the marked location.

Place the attachment back in position and install a Grade 5 1/2" hex bolt with a lockwasher and nut. If the location of the hole in your bucket is where the steel is thin, then it is recommended that a flat washer be installed on the top side of the loader bucket floor.

Tighten the 1/2" bolt securely.

ASSEMBLY – CLAMP-ON UNITS

Check your loader to make sure it is in good working order.

Refer to the exploded parts view of the CBSF-2000 on page 13. Slide the tube through the hole in the formed angle and align the bolt holes. Install the two 1/2" x 1 1/2" bolts and tighten. Insert the spear and align the horizontal hole in the tube with the hole in the spear. Insert the 1/2" x 3" bolt and tighten.

ASSEMBLY – CLAMP-ON (continued)

Refer to the exploded parts views in this manual for proper orientation of the chain, bolt, and washer.

Install the chain on the clamp-on attachment with the 1/2" hex bolt and locknut provided. Make sure that the flat washer is next to the chain link to provide more support for the chain.

Install the turnbuckle on the bucket attachment with the 3/4" bolt and nut. Check the turnbuckle to make sure that it operates easily. Spreading some grease on the threads will help insure that it will remain free and easy to use.

Slide the front cutting edge of your loader bucket under the lip of the bucket attachment.

Raise the loader slightly so that the bottom of clamp-on attachment is about three or four inches off the ground. Engage tractor parking brake and shut off the engine.

Place some solid blocking under the bottom of the bale handling attachment for safety.

Install the chain around the loader bucket and into the keyhole slot on the upper end of the turnbuckle. Slide the chain through the keyhole slot until the chain around the bucket is fairly tight – then tighten by turning the turnbuckle body. Tighten the chain so that the loader attachment and chain are securely fastened to the loader bucket.

If necessary, loosen the turnbuckle and relocate the keyhole slotted end to another chain link and retighten the turnbuckle.

Turn the locknut on the turnbuckle up tight against the end of the turnbuckle barrel and tighten with a wrench.



WARNING

DO NOT operate loader and attachment if it is not securely fastened to the loader bucket. If loose, the bale and attachment could come off the loader bucket creating a dangerous situation that could lead to personal injury or death.

SAFETY INSTRUCTIONS (continued)



STORAGE SAFETY



Following operation, or when unhooking, stop the tractor, set the brakes, lower loader, shut off the engine, relieve hydraulic pressure and remove the ignition keys.



Store the unit in an area away from human activity.



Do not park equipment where it will be exposed to livestock for long periods of time. Damage and livestock injury could result.



Do not permit children to play on or around the stored unit.



Make sure all parked machines are on a hard, level surface and engage all safety devices.



If blocking is used, make sure it is solid and secure before leaving area.



SAFETY SIGNS



Keep safety signs clean and legible at all times.



Replace safety signs that are missing or have become illegible.

Replaced parts that displayed a safety sign should also display the current sign.

Safety signs are available from your Distributor or Dealer Parts Department or the factory.

How to Install Safety Signs:

- Be sure that the installation area is clean and dry.
- Be sure temperature is above 50°F (10°C).
- Decide on the exact position before you remove the backing paper.
- Remove the smallest portion of the split backing paper.
- Align the sign over the specified area and carefully press the small portion with the exposed sticky backing in place.
- Slowly peel back the remaining paper and carefully smooth the remaining portion of the sign in place.
- Small air pockets can be pierced with a pin and smoothed out using the piece of sign backing paper.

SAFETY SIGNS

WARNING

- Read and follow owner's manual before installing, operating, or performing maintenance on this attachment. Observe safety recommendations in manual.
- Do not exceed weight limit of attachment or tractor.
- Do not lift or carry anyone on attachment.
- Attachment should be used with the proper weight package on front of tractor or with a loader installed. When handling loads on both ends of tractor, load rear first and unload last.
- Set wheels wide for increased stability.
- Never raise load to extreme heights on steep inclines.
- When handling large round bale, keep load as low as practical to maximize tractor stability.
- Make sure large round bale transported on tractor rear three point hitch attachment does not obstruct visibility of tractor's flashing lights or SMV sign.
- Do not stand or work under raised attachment.
- Stop engine, lower arms, relieve all hydraulic pressure, and lock brakes before leaving operator's seat.
- Failure to observe the above precautions can result in serious injury or death.

101277

WARNING

Always insert spears in bale – never under bale.
Failure to do this can allow bale roll back when loader is raised, causing serious injury or death.

101127

(CBSF-2028 & CBSF-3028 ONLY)

BE CAREFUL!

Use a clean, damp cloth to clean safety decals. Avoid spraying to close to decals when using a pressure washer; high-pressure water can enter through very small scratches or under edges of decals causing them to peel or come off.

REMEMBER: If Safety Signs have been damaged, removed, become illegible or parts replaced without Signs, new Safety Signs must be applied. New Safety Signs are available from your authorized distributor or factory.

**Replace
Safety Decals
if damaged
or missing.**

INSTRUCTIONS

INTRODUCTION

The bolt-on and clamp-on loader bucket attachments provide a means of leaving the bucket on your tractor loader and easily converting the loader to handle large, round bales.

The attachments are easily installed or removed from your front loader in minutes. The model BBSF-20 mounts under the loader bucket with the weight of the bale carried on the front edge or lip of the bucket. The 1/2" bolt holds the attachment to the bucket.

The clamp-on loader bucket attachments provide a means of leaving the bucket on your tractor loader and easily converting the loader to handle large, round bales.

The attachments are easily installed or removed from your front loader in minutes. A chain and turnbuckle provide a secure, easy means of clamping the attachment to your loader bucket.

CAUTION

Bucket attachments hold the load in front of the loader bucket. The loader must have a lift capacity 1000 lbs. greater than the weight of the bale to be handled. If the loader does NOT have this capacity, then a different attachment that requires the removal of the bucket should be considered.

NOTE: The maximum load for the attachments is as follows:

BBSF-20	2,000 lbs.
CBSF-2000	2,000 lbs.
CBSF-2028	3,000 lbs.
CBSF-3028	4,000 lbs.

TRACTOR AND LOADER REQUIREMENTS AND PREPARATION

The required size of the tractor and front loader will be determined by the size and weight of the bales to be handled.

Remember, high moisture hay (silage) bales are very heavy in relation to similar size dry hay bales.

Always use a tractor and front loader large enough to safely handle your bales.

Check your tractor and front loader to make sure they are in good working condition. Check all frame mounting bolts to make sure they are tight.

Loaders that attach to the tractor frame rails should have a cross-tie installed for stability.

Check the hydraulic system. Be sure the tractor hydraulic oil and filter have been serviced according to the tractor manufacturer's recommendations.

CAUTION

Be sure your tractor is in good condition and properly equipped with counter weights. Read all the safety precautions and make sure all tractor operators are familiar with the safety rules of tractor operation.

WARNING

A heavy load can cause instability in driving a tractor. Make sure the front or rear of the tractor is properly counter-balanced with weights. Always drive slowly – especially around turns. An unstable tractor could steer badly and possibly tip over, causing injury or death.

The use of any loader attachment is NOT recommended on tractors with a tricycle wheel arrangement. Tricycle type tractors are unstable for front loader use.

WARNING

Do not exceed the maximum recommended large round bale weight listed for each of the loader spear models. Damage to the equipment or serious personal injury could result.

WARNING

Power unit must be equipped with ROPS or ROPS cab and seat belt. Keep seat belt securely fastened. Falling off power unit can result in death from being run over or crushed. Keep foldable ROPS systems in "locked up" position at all times.

The operator is responsible for the safe operation of this equipment. The operator must be properly trained. Operators should be familiar with the tractor and attachment, and all safety practices before starting operation. Read the safety rules and safety signs on pages 1-7.