

# OWNER'S/ OPERATOR'S MANUAL

## MODEL NO.'s

**SSB-2200**

**SSB-3000**

**SSRB-330**

**SSRB-340**

### **CAUTION**

For Safe Operation  
Read Rules And  
Instructions Carefully

SI NO LEEINGLES, PIDA AYUDA  
A AIGUIEN QUE SI LO LEA  
PARA QUE LE TRADUZCA LAS  
MEDIDAS DE SEGURIDAD.

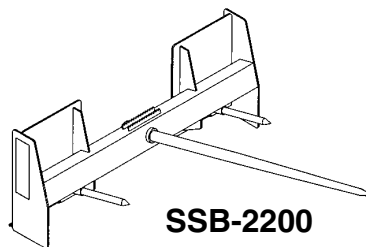

**SSB-2200**

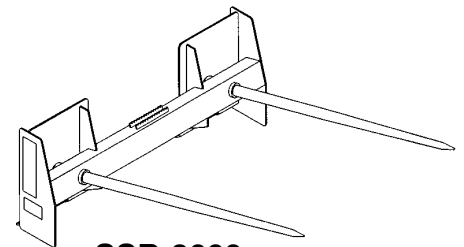

**SSB-3000**

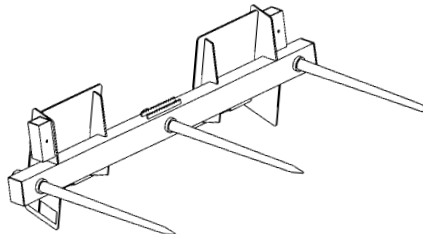

**SSRB-330**

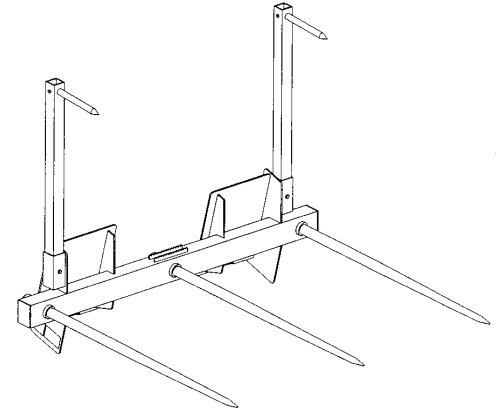

**SSRB-340 w/ Opt.**

## **SKID STEER and TRACTOR LOADER BALE SPEAR ATTACHMENTS**

**Safety Instructions  
Tractor Preparation  
Operating Instructions**

**Assembly & Mounting  
Maintenance  
Repair Parts**

### **CAUTION**

#### **THE FOLLOWING SAFETY PRECAUTIONS SHOULD BE THOROUGHLY UNDERSTOOD BEFORE ATTEMPTING TO BEGIN ASSEMBLING THIS MACHINE**

1. Select an area for assembly that is clean and free of any debris which might cause persons working on the assembly to trip.
2. Do not lift heavy parts or assemblies. Use crane, jack, tackle, fork trucks or other mechanical devices.
3. Preview the assembly instructions in your operator's manual before proceeding further.
4. If the assembly instructions call for parts or assemblies to be blocked up, use only blocking material that is in good condition and is capable of handling the weight of the assembly to be blocked. Also insure that the blocking material is on a clean, dry surface.
5. Never put hands, or any part of body, under blocked up assemblies if at all possible.
6. After completing assembly, thoroughly inspect the machine to be sure that all nuts, bolts, hydraulic fittings or any other fastened assemblies have been thoroughly tightened.
7. Before operating the machine, thoroughly read the operation section of your operator's manual.
8. Before operating, read the maintenance section of your operator's manual to be sure that any parts requiring lubrication, such as gearboxes, are full, to avoid any possible damage.
9. **Before operating equipment – If you have any questions regarding the proper assembly or operation, contact your dealer or representative.**

# TABLE OF CONTENTS

SI NO LEEINGLES, PIDA AYUDA A AIGUIEN QUE SI LO LEA PARA QUE LE TRADUZCA LAS MEDIDAS DE SEGURIDAD.

WARRANTY .....	2
SAFETY INFORMATION .....	3
SAFETY SIGNS .....	11
PREPARATION INSTRUCTIONS .....	12
OPERATING INSTRUCTIONS .....	14
PARTS LISTS .....	16-19

## STATEMENT OF POLICY

It is the policy of Worksaver, Inc. to improve its products where it is possible and practical to do so. Worksaver, Inc. reserves the right to make changes or improvements in design and construction at any time, without incurring the obligation to make these changes on previously manufactured units.

## TO THE OWNER:

Read this manual before using your Bale Spear Attachment. This manual is provided to give you the necessary operating and maintenance instructions for keeping your Bale Spear Attachment in top operating condition. Please read this manual thoroughly. Understand what each control is for and how to use it. Observe all safety signs on the machine and noted throughout the manual for safe operation of implement. Keep this manual handy for ready reference.

Like all mechanical products, it will require cleaning and upkeep.

Use only genuine Worksaver, Inc. service parts. Substitute parts will void the warranty and may not meet standards required for safe and satisfactory operation. Record the model and serial number of your Attachment here:

Model: \_\_\_\_\_ Serial Number: \_\_\_\_\_

---

---

## RETAIL CUSTOMER'S RESPONSIBILITY

**It is the Retail Customer and/or Operator's responsibility to read the Operator's Manual, to operate, lubricate, maintain, and store the product in accordance with all instructions and safety procedures. Failure of the operator to read the Operator's Manual is a misuse of this equipment.**

**It is the Retail Customer and/or Operator's responsibility to inspect the product and to have any part(s) repaired or replaced when continued operation would cause damage or excessive wear to other parts or cause a safety hazard.**

**It is the Retail Customer's responsibility to deliver the product to the authorized Worksaver Dealer, from whom he purchased it, for service or replacement of defective parts which are covered by warranty. Repairs to be submitted for warranty consideration must be made within forty-five (45) days of failure.**

**It is the Retail Customer's responsibility for any cost incurred by the Dealer for traveling to or hauling of the product for the purpose of performing a warranty obligation or inspection.**

# LIMITED WARRANTY



Worksaver warrants to the original purchaser of any new Bale Spear Attachment, that the equipment be free from defects in material and workmanship for a period of six (6) months for non-commercial, state, and municipalities. Use sixty (60) days for commercial use from date of retail sale.

Replacement or repair parts installed in the equipment covered by this warranty are warranted for ninety (90) days from the date of purchase of such part or to the expiration of the applicable new equipment warranty period, whichever occurs later.

Such parts shall be provided at no cost to the user during regular working hours. Worksaver reserves the right to inspect any equipment or parts which are claimed to have been defective in material or workmanship.

## DISCLAIMER OF IMPLIED WARRANTIES & CONSEQUENTIAL DAMAGES

Worksaver's obligation under this warranty, to the extent allowed by law, is in lieu of all warranties, implied or expressed, including implied warranties of merchantability and fitness for a particular purpose and any liability for incidental and consequential damages with respect to the sale or use of the items warranted. Such incidental and consequential damages shall include but not be limited to: transportation charges other than normal freight charges; cost of installation other than cost approved by Worksaver; duty; taxes; charges for normal service or adjustments; loss of crops or any other loss of income; rental of substitute equipment, expenses due to loss, damage, detention or delay in the delivery of equipment or parts resulting from acts beyond the control of Worksaver.

## THIS WARRANTY SHALL NOT APPLY:

1. To vendor items which carry their own warranties, such as hydraulic cylinders, tires, and tubes.
2. If the unit has been subjected to misapplication, abuse, misuse, negligence, fire or other accident.
3. If parts not made or supplied by Worksaver have been used in connection with the unit, if, in sole judgement of Worksaver such use affects its performance, stability, or reliability.
4. If the unit has been altered or repaired outside of an authorized Worksaver dealership in a manner which, in the sole judgement of Worksaver affects its performance, stability or reliability.
5. To normal maintenance service and normal replacement items such as gearbox lubricant, hydraulic fluid, worn blades, or to normal deterioration of such things as belts and exterior finish, due to use or exposure.
6. To expendable or wear items such as teeth, chains, sprockets, belts, springs and other items that in the company's sole judgement is a wear item.

NO EMPLOYEE OR REPRESENTATIVE OF WORKSAVER IS AUTHORIZED TO CHANGE THIS WARRANTY IN ANY WAY OR GRANT ANY OTHER WARRANTY UNLESS SUCH CHANGE IS MADE IN WRITING AND SIGNED BY WORKSAVER'S SERVICE MANAGER, POST OFFICE BOX 100, LITCHFIELD, ILLINOIS 62056-0100.



# To the Owner/Operator/Dealer

All implements with moving parts are potentially hazardous. There is no substitute for a cautious, safe-minded operator who recognizes the potential hazards and follows reasonable safety practices. The manufacturer has designed this implement to be used with all its safety equipment properly attached to minimize the chance of accidents.

## BEFORE YOU START!!

**Read the safety messages on the implement and shown in your manual.  
Observe the rules of safety and common sense!**



**THIS SYMBOL MEANS**

- ATTENTION!
- BECOME ALERT!
- YOUR SAFETY IS INVOLVED!

THIS SAFETY ALERT SYMBOL IDENTIFIES IMPORTANT SAFETY WARNING MESSAGES. CAREFULLY READ EACH WARNING MESSAGE THAT FOLLOWS. FAILURE TO UNDERSTAND AND OBEY A SAFETY WARNING, OR RECOGNIZE A SAFETY HAZARD, COULD RESULT IN AN INJURY OR DEATH TO YOU OR OTHERS AROUND YOU. THE OPERATOR IS ULTIMATELY RESPONSIBLE FOR THE SAFETY OF HIMSELF, AS WELL AS OTHERS, IN THE OPERATING AREA OF THE TRACTOR AND EQUIPMENT.

---

## UNDERSTAND SIGNAL WORDS



**DANGER**

Indicates an imminently hazardous situation that, if not avoided, WILL result in DEATH OR VERY SERIOUS INJURY.



**WARNING**

Indicates a imminently hazardous situation that, if not avoided, COULD result in DEATH OR SERIOUS INJURY.



**CAUTION**

Indicates a imminently hazardous situation that, if not avoided, MAY result in MINOR INJURY.

**IMPORTANT**

Identifies special instructions or procedures that, if not strictly observed, could result in damage to, or destruction of the machine, attachments or the environment.

**NOTE:** *Identifies points of particular interest for more efficient and convenient operation or repair.*

If you have questions not answered in this manual or require additional copies or the manual is damaged, please contact your dealer or the manufacturer directly.

---

## Important Safety Information!

Working with equipment can lead to injuries. Read this manual, and the manual for your tractor, before assembly or operating, to acquaint yourself with the machine. It is the equipment owner's responsibility, if this equipment is used by any person other than yourself, is loaned or rented, to make certain that the operator, prior to operating:

1. Reads and understands the operator's manuals.
2. Is instructed in safe and proper use.













The use of this equipment is subject to certain hazards which cannot be protected against by mechanical means or product design. All operators of this equipment must read and understand this entire manual, paying particular attention to safety and operating instructions, prior to using. If there is something in this manual you do not understand, ask your supervisor, or your dealer, to explain it to you.

# SAFETY INSTRUCTIONS (continued)



## EQUIPMENT SAFETY GUIDELINES

-  Safety of the operator is one of the main concerns in designing and developing a new piece of equipment. Designers and manufacturers build in as many safety features as possible. However, every year many accidents occur which could have been avoided by a few seconds of thought and a more careful approach to handling equipment. You, the operator, can avoid many accidents by observing the following precautions in this section. To avoid personal injury, study the following precautions and insist those working with you, or for you, follow them.
  
-  In order to provide a better view, certain photographs or illustrations in this manual may show an assembly with a safety shield removed. However, equipment should never be operated in this condition. Keep all shields in place. If shield removal becomes necessary for repairs, replace the shield prior to use.
  
-  Replace any CAUTION, WARNING, DANGER or instruction safety sign that is not readable or is missing. Location of such safety signs is indicated in this booklet. Do not paint over, remove or deface any safety signs or warning signs on your equipment. Observe all safety signs and practice the instruction on them.
  
-  Never use alcoholic beverages or drugs which can hinder alertness or coordination while operating this equipment. Consult your doctor about operating this machine while taking prescription medications.
  
-  Review the safety instructions with all users annually.
  
-  This equipment is dangerous to children and persons unfamiliar with its operation. The operator should be a responsible adult familiar with farm machinery and trained in this equipment's operations. **Do not allow persons to operate or assemble this unit until they have read this manual and have developed a thorough understanding of the safety precautions and of how it works.**
  
-  To prevent injury or death, use a power unit equipped with a Roll-Over Protective System (ROPS). Keep foldable ROPS systems in "locked up" position at all times. Keep seat belt fastened.
  
-  Never exceed the limits of a piece of machinery. If its ability to do a job, or to do so safely, is in question – **DON'T TRY IT.**
  
-  Do not modify the equipment in any way. Unauthorized modification may impair the function and/or safety and could affect the life of the equipment.
  
-  In addition to the design and configuration of this implement, including Safety Signs and Safety Equipment, hazard control and accident prevention are dependent upon the awareness, concern, prudence, and proper training of personnel involved in the operation, transport, maintenance, and storage of the machine. Refer also to Safety Messages and Operation Instructions in each of the appropriate sections of the Skid Steer and Implement Manuals. Pay close attention to the Safety Signs affixed to the Power Unit and the Implement.

# SAFETY INSTRUCTIONS (continued)



## SAFETY SIGNS

Keep safety signs clean and legible at all times.

Replace safety signs that are missing or have become illegible.

Replaced parts that displayed a safety sign should also display the current sign.

Safety signs are available from your Distributor or Dealer Parts Department or the factory.

### **How to Install Safety Signs:**

Decide on the exact position before you remove the backing paper.

Remove the smallest portion of the split backing paper. Align the sign over the specified area and carefully press the small portion with the exposed sticky backing in place.

Slowly peel back the remaining paper and carefully smooth the remaining portion of the sign in place. Small air pockets can be pierced with a pin and smoothed out using the piece of sign backing paper.



## SAFETY TRAINING



Safety is a primary concern in the design and manufacture of our products. Unfortunately, our efforts to provide safe equipment can be wiped out by a single careless act of an operator. It is the operator's responsibility to read and understand ALL Safety and Operating instructions in the manual and to follow these. Accidents can be avoided.



In addition to the design and configuration of equipment, hazard control and accident prevention are dependent upon the awareness, concern, prudence and proper training of personnel involved in the operation, transport, maintenance and storage of equipment.



Read this manual, and the manual for your skid steer, before assembly or operating, to acquaint yourself with the machines. It is the owner's responsibility, if this machine is used by any person other than yourself, is loaned or rented, to make certain that the operator, prior to operating:

1. Reads and understands the operator's manuals.
2. Is instructed in safe and proper use.



Know your controls and how to stop power unit, engine, and attachment quickly in an emergency. Read this manual and the one provided with your power unit.



Train all new personnel and review instructions frequently with existing workers. A person who has not read and understood all operating and safety instructions is not qualified to operate the machine. An untrained operator exposes himself and bystanders to possible serious injury or death.















Do not allow children to operate this machine.

# SAFETY INSTRUCTIONS (continued)



## OPERATIONAL SAFETY

-  Start power unit only when properly seated in the operator's seat. Starting a power unit in gear can result in injury or death. Do not mount or dismount while the power unit is moving. Mount or dismount only when the power unit and all moving parts are completely stopped.
-  Operate the power unit and/or implement controls only while properly seated in the operator's seat with the seat belt securely fastened around you. Inadvertent movement of the power unit or implement may cause serious injury or death.
-  Never leave the power unit and implement unattended while the implement is in the lifted position. Accidental operation of lifting lever or a hydraulic failure may cause sudden drop of unit with injury or death by crushing.
-  Know your controls and how to stop power unit, engine, and implement quickly in an emergency. Read this manual and the one provided with your power unit.
-  Check that this attachment is securely mounted to the loader. Failure to install lock pins or have the latching mechanism engage could result in injury or death.
-  Keep all helpers and bystanders at least fifty (50) feet from an operating unit. Only properly trained people should operate this machine.
-  Do not walk or work under a raised bale spear attachment unless it is securely blocked or held in position. Do not depend on the hydraulic system to hold the loader and attachment in place.
-  A heavy load can cause instability of the skid steer or tractor. Use extreme care during travel. Slow down on turns and watch out for bumps. The skid steer or tractor may need additional counter-weights to counter-balance the weight of the bale.
-  Do not allow children or others to ride on the power unit with an operator. Riders are subject to injury such as being struck by foreign objects or being thrown off. Riders obstruct the operator's view resulting in unsafe operation. **Never allow anyone to ride on the implement!**
-  Never allow children to play on or around power unit or implement. Children can slip or fall off the equipment and be injured or killed. Inadvertent contact with controls can cause the implement to shift or fall crushing themselves or others.
-  Keep all helpers and bystanders at a safe distance. **REMEMBER FALLING BALES CAN ROLL OR TUMBLE.**
-  Beware of low electrical wires when loader is raised. Serious injury or death can result if contact is made.

# SAFETY INSTRUCTIONS (continued)



## OPERATIONAL SAFETY (continued)



Always insert spears into the bale – NEVER under the bale. Failure to insert spears into bale can allow bale to roll back when loader is raised, causing serious injury or death.



Do not handle bales that exceed the bale weight limitations of the skid steer or tractor/loader.



Carry the bale slowly and as low as possible to the ground. Avoid excessive speed during operation.



Operate the loader controls smoothly, avoiding jerky operation. Stop loader gradually when lowering or lifting loads.



When handling round bales on a slope, always approach the bale with the power unit facing uphill.



Never use the tractor/loader or skid steer to stop a rolling bale.



Be sure that people, livestock, or pets are not standing near the machine while operating.



When stacking bales, ALWAYS MAKE SURE BALES ARE PLACED SO THE STACK IS STABLE.



Beware of lift clearance when raising loader to maximum height.



Keep alert and watch the rear as well as the front when working with the loader.



When maneuvering close to buildings or passing through narrow areas, be sure to allow sufficient clearance for the power unit and attachment. Drive slowly.



Operate loader from operator's seat only. Remain at controls until operating cycle is complete.



Relieve hydraulic pressure prior to doing any maintenance or repair work on the implement. Place the implement on the ground or securely blocked up, disengage the PTO, and turn off the power unit engine. Push and pull the remote hydraulic lever in and out several times prior to starting any maintenance or repair work.



Never allow anyone to walk or work under a raised loader.



Do not lift or carry anyone on loader or in bucket or on attachment.















ALWAYS lower loader to the ground or block securely before performing any maintenance work.



# SAFETY INSTRUCTIONS (continued)



## OPERATIONAL SAFETY (continued)

-  Stay alert for holes, rocks and roots in the terrain and other hidden hazards. Keep away from drop-offs.
-  Use extreme care and maintain minimum ground speed when transporting on hillside, over rough ground and when operating close to ditches or fences. Be careful when turning sharp corners.
-  Reduce speed on slopes and sharp turns to minimize tipping or loss of control. Be careful when changing directions on slopes. Do not start or stop suddenly on slopes. Avoid operation on steep slopes.
-  Always drive down slopes; never across the face. Avoid operation on steep slopes. Slow down on sharp turns and slopes to prevent tipping and/or loss of control. Avoid slopes when surface is wet, slippery grass or soil.
-  NEVER try to handle two rectangular bales at once without the 831095 optional bolt-on uprights installed. Failure to use the uprights can allow the top bale to roll back when loader is raised, causing serious injury or death.
-  Please remember it is important that you read and heed the safety signs on the front loader attachment and loader, and the safety rules set forth. Clean or replace all safety signs if they cannot be clearly read and understood. They are there for your safety as well as the safety of others. The safe use of this machine is strictly up to you, the operator. Observe Safety Recommendations in loader instruction manual.
-  Always keep power unit on solid footing when operating loader.
-  Observe safety recommendations in loader instruction manual.
-  Inspect the entire machine periodically as indicated in the Maintenance Section of this manual. Look for loose fasteners, worn or broken parts, pinched hydraulic hoses, and leaky or loose fittings. Make sure all pins have cotter pins and washers. Serious injury may occur from not maintaining this machine in good working order.
-  Avoid excessive speed during operation.
-  ALWAYS lower spear points to the ground when parking power unit. Raised spear points could cause injury to people or livestock.
-  Always shut off power unit and shift to "Park" or set brakes when leaving unit. Always lower bucket or attachment to ground. Remove key when leaving unit unattended. Park in level area.
-  Before operating equipment: if you have any questions regarding the proper assembly or operation, contact your dealer or representative.

# SAFETY INSTRUCTIONS (continued)



## TRANSPORT SAFETY



Comply with state and local laws governing highway safety and movement of farm machinery on public roads.



The use of flashing amber lights is acceptable in most localities. However, some localities prohibit their use. Local laws should be checked for all highway lighting and marking requirements.



When driving the power unit and attachment on the road or highway under 20 mph (32 kph) at night or during the day, use flashing amber warning lights and a slow moving vehicle (SMV) identification emblem.



Always be sure the loader is in the proper raised position for transport.



Reduce speed when transporting mounted implements to avoid bouncing and momentary loss of steering control.



Transporting large round bales on tractor/loaders or skid steer units can limit visibility. Keep load low and go slow if visibility is obstructed. Always use extra care.



Turn curves or go up or down hills only at a low speed and at a gradual steering angle. Slow down on rough or uneven surfaces, and loose gravel.



Use extreme care and maintain minimum ground speed when transporting on hillside, over rough ground and when operating close to ditches or fences. Be careful when turning sharp corners.



Never allow riders on either power unit or attachment. Falling off can kill.



## MAINTENANCE SAFETY

**Good maintenance is your responsibility. Poor maintenance is an invitation to trouble.**



Before working on this machine, drive to a level area, disengage the PTO, lower implement (or if working underneath, raise and block securely), shut off the engine, set the brakes, and remove the ignition keys.



Always use two people to handle heavy, unwieldy components during assembly, installation, removal, or moving the implement.



Keep all persons away from operator control area while performing adjustments, service, or maintenance.









Never work under equipment unless it is blocked securely. Never depend on hydraulic system to keep implement in raised position.

# SAFETY INSTRUCTIONS (continued)



## MAINTENANCE SAFETY (continued)





-  Periodically tighten all bolts, nuts and screws and check that all cotter pins are properly installed to ensure unit is in a safe condition.
-  When completing a maintenance or service function, make sure all safety shields and devices are installed before placing unit in service.
-  Never use your hands to locate a hydraulic leak on attachments. Use a small piece of cardboard or wood. Hydraulic fluid escaping under pressure can penetrate the skin.
-  Openings in the skin and minor cuts are susceptible to infection from hydraulic fluid. If injured by escaping hydraulic fluid, see a physician at once. Gangrene and death can result. Without immediate medical treatment, serious infection and reactions can occur.
-  Check to ensure all safety signs are installed and in good condition. (See safety sign section for location drawing.)
-  Always use personal protection devices such as eye, hand and hearing protectors, when performing any service or maintenance.

Where replacement parts are necessary for periodic maintenance and servicing, genuine factory replacement parts must be used to restore your equipment to original specifications. The manufacturer will not claim responsibility for use of unapproved parts and/or accessories and other damages as a result of their use.

If equipment has been altered in any way from original design, the manufacturer does not accept any liability for injury or warranty.



## STORAGE SAFETY

-  Following operation or when unhooking, stop the power unit, set the brakes, lower the loader, shut off the engine and remove the ignition keys.
-  Store the unit in an area away from human activity. Do not permit children to play on or around the stored unit.
-  Do not park equipment where it will be exposed to livestock for long periods of time. Damage and livestock injury could result.
-  Make sure all parked machines are on a hard, level surface and engage all safety devices.
-  If blocking is used, make sure it is solid and secure before leaving area.

# SAFETY SIGNS

## **WARNING**

Always insert spears in bale – never under bale.  
Failure to do this can allow bale roll back when loader is raised, causing serious injury or death.

101127

(Models SSB-3000, SSRB-330, SSRB-340)



### **WARNING**

To avoid injury or death caused by falling attachment:  
Lockpins must completely engage attachment plate slots.

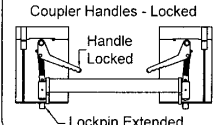

Coupler Handles - Locked  
Handle Locked  
Lockpin Extended

101313

## **BE CAREFUL!**

Use a clean, damp cloth to clean safety decals. Avoid spraying to close to decals when using a pressure washer; high-pressure water can enter through very small scratches or under edges of decals causing them to peel or come off.

## **REMEMBER:**

If Safety Signs have been damaged, removed, become illegible or parts replaced without Signs, new Safety Signs must be applied. New Safety Signs are available from your authorized distributor or factory.

## **WARNING**

- Read and follow owner's manual before installing, operating, or performing maintenance on this attachment. Observe safety recommendations in manual.
- Do not exceed weight limit of attachment or tractor.
- Do not lift or carry anyone on attachment.
- Attachment should be used with the proper weight package on front of tractor or with a loader installed. When handling loads on both ends of tractor, load rear first and unload last.
- Set wheels wide for increased stability.
- Never raise load to extreme heights on steep inclines.
- When handling large round bale, keep load as low as practical to maximize tractor stability.
- Make sure large round bale transported on tractor rear three point hitch attachment does not obstruct visibility of tractor's flashing lights or SMV sign.
- Do not stand or work under raised attachment.
- Stop engine, lower arms, relieve all hydraulic pressure, and lock brakes before leaving operator's seat.
- Failure to observe the above precautions can result in serious injury or death.

101277

# INSTRUCTIONS

## LOADER REQUIREMENTS AND PREPARATION

The Bale Spear Attachments are designed to fit skid steer units or tractor/loader with the “Universal” (Bobcat) style quick-attach loaders.

Remove the bucket from your skid steer unit or tractor/loader. Check the loader arms and cylinders to make sure they are in good working order. Lubricate all loader pivot points. Check all bolts to make sure they are in place and tight.

Be sure the power unit’s hydraulic oil and filter have been serviced according to the manufacturer’s recommendations.



### CAUTION

**Be sure your power unit is in good condition. Read all the safety precautions and make sure all loader operators are familiar with the safety rules of operation.**

The maximum recommended weight of large round bales that can be handled by the various models of bale spears are as follows:

Model	Spear Type	Bale Weight
SSB-2200	Forged	Up to 2200 lb.
SSB-3000	Forged (2)	Up to 3000 lb.
SSRB-340	Forged (3)	Up to 4000 lb.
SSRB-330	Forged (3)	Up to 3000 lb.

The required size of the power unit/loader will be determined by the size and weight of the bales to be handled.

Remember, high moisture hay (silage) bales are very heavy in relation to similar size dry hay bales.

Always use a power unit/loader large enough to safely handle your bales.

Always be sure your power unit is properly counterbalanced for a safe operation.  **It is a good practice to use a loader with an equal or greater SAE operating load capacity.**



### CAUTION

**Do not exceed the maximum recommended bale weight listed for each of the loader spear models. Damage to the equipment or serious personal injury could result.**



### CAUTION

**A heavy load can cause instability in driving a skid steer or tractor/loader. Make sure the rear of the power unit is properly counter-balanced with weights. Always drive slowly – especially around turns. An unstable power unit could steer badly and possibly tip over, causing injury or death.**

## ASSEMBLY

These units are shipped almost completely assembled. Carefully follow instructions for final assembly.

Before attempting assembly check the following items. Having all the needed parts and equipment readily at hand will speed up your assembly task and will make the job as safe as possible.

Refer to the Safety Precautions and Warnings on the front cover and in the Safety Section of this manual prior to working on the machine.

Refer to the “exploded view” of the bale spear attachments shown in this manual. Become familiar with the relationship of the various components and parts shown.

For the Model SSB-2200, insert the long, forged spear into the socket and align the cross hole in the spear with the cross hole in the socket. Install the 1/2” x 3” bolt and tighten the nut.

Place the two (2) stabilizer spikes into the sockets on the bottom of the main frame. Secure with the 3/8” x 1 3/4” bolts provided.

Go back over all of the bolts and check to be sure they are tight before using the Bale Spear attachment.

With the Model SSB-3000 and SSRB Models, install the long, forged main spears into the sockets in the main frame as described for the single spear model above.

Connect the bale spear attachment mount frame to the “universal” quick-attach plate on your loader. Flip the spring loaded latch pins to the “latch lock” position and check to see they are properly latched.

# INSTRUCTIONS (continued)

## ATTACHMENT TO PRIME MOVER



### WARNING

Improper attachment of the attachment could result in injury or death. Do not operate this product until you have positive indication that the attachment is securely mounted.

1. Position the attachment on a level surface.
2. The quick attach coupler handles should be in the unlocked position with lock pins retracted, Figure 2.

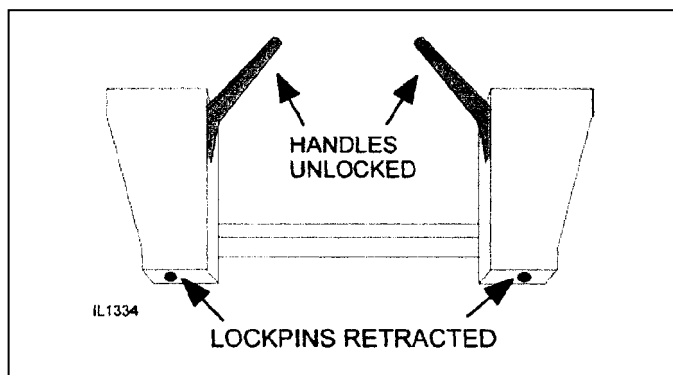

Figure 2. Quick Attach Coupler Handles - Unlocked

3. Enter the prime mover. Fasten seatbelt, start engine. Disengage the parking brake.
4. Follow the attaching procedure in the prime mover owner's manual. Align the loader attachment mechanism with the mounting on the implement, attach to the prime mover on loader.
5. Engage the parking brake and shut down the prime mover. Be sure to relieve pressure to the auxiliary hydraulic lines.
6. Unfasten safety restraints and exit the prime mover.
7. Engage the latching mechanism to secure attachment to loader. The lockpins must be completely extended and secured into the retaining slots.
8. Re-enter the prime mover. Fasten seatbelt and restart engine.

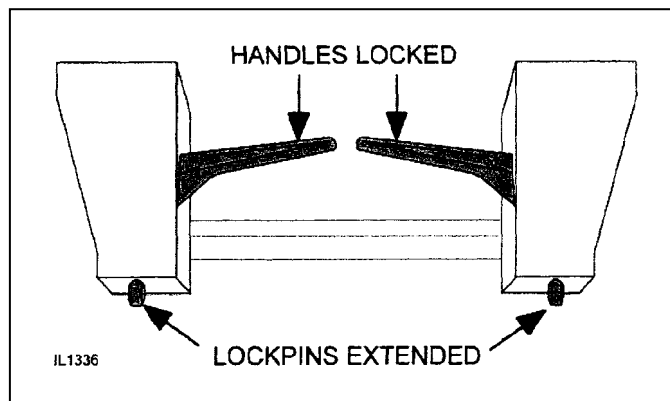

Figure 3. Attachment Coupler Handles - Locked



### WARNING

Attachment coupler handles must always be rotated to LOCK POSITION to prevent coupler latch from disengaging and attachment from falling off.

9. Carefully raise the loader and cycle the rollback/tilt cylinders to check clearances and to ensure that the attachment is securely mounted.

## REMOVING THE POST DRIVER

1. If possible, find a level solid location to place the attachment. This makes it easier to disconnect and re-connect later on.
2. Lower the attachment to the ground.
3. Engage the parking brake and shut down the prime mover. Be sure to relieve pressure to the auxiliary hydraulic lines.
4. Unfasten safety restraints and exit prime mover.
5. Disengage attachment-locking mechanism (mechanical type).
6. Enter prime mover, fasten safety restraints and start the prime mover.
7. Disengage attachment-locking mechanism (hydraulic type).
8. Disengage the parking brake, and back away from the attachment.

# INSTRUCTIONS (continued)

## OPERATION

The operator is responsible for the safe operation of this equipment. The operator must be properly trained. Operators should be familiar with the attachment and power unit/loader and all safety practices before starting operation. Read the safety rules and safety signs on pages 3-11.

### LARGE ROUND BALES:

Using the bucket tilt cylinders, adjust the angle of the spear(s) so they are parallel with the center of the hay bale.

With the power unit, push the spear(s) into the large hay bale. Make sure you have penetrated the hay bale far enough so the bale doesn't want to come off the end of the spear(s). If, when you initially pick the bale up, it tends to droop forward, this would indicate you have not penetrated the bale far enough.

Tilt the ends of the spear(s) upward (about 15-20 degrees) when transporting the hay bales. This will reduce any tendency for the bale to slide off the spear(s) while being transported.

When you have placed the hay bale in the desired location, it is recommended to tilt the spear ends slightly downward (5-7 degrees) so as you pull away from the bale it will slide off the spear(s) more easily. Different location and circumstances will determine the best withdraw angle to use.

**NOTE:** Always make sure bale spear fully penetrates the bale. Partial penetration locates all the weight of the bale on the outer end and can damage spear.

**NOTE:** In cold weather, a bale frozen to the ground may exceed the lifting capacity of spear and loader. Damage to spear or loader may occur. Not covered under warranty.

**NOTE:** Soft center bales will tend to droop after being lifted by a single spear. Placing the spear in a lower position in the bale will allow for more lifting height and lessen the load on the stabilizer spears.



## CAUTION

**NEVER LET ANYONE CLIMB ON STACKED ROUND HAY BALES!**

### RECTANGULAR BALES:

Using the bucket tilt cylinders, adjust the angle of the spear(s) so they are parallel with the center of the hay bale. Center the spears with the width of the bale.

With the power unit, push the spear(s) into the large hay bale. Make sure you have penetrated the hay bale far enough so the bale doesn't want to come off the end of the spear(s). If, when you initially pick the bale up, it tends to droop forward, this would indicate you have not penetrated the bale far enough.

Tilt the ends of the spear(s) upward (about 15-20 degrees) when transporting the hay bales. This will reduce any tendency for the bale to slide off the spear(s) while being transported.

When you have placed the hay bale in the desired location, it is recommended to tilt the spear ends slightly downward (5-7 degrees) so as you pull away from the bale it will slide off the spear(s) more easily. Different location and circumstances will determine the best withdraw angle to use.

**NOTE:** Optional bolt-on uprights are available to transport two rectangular bales at a time (see page 18). Order #831095 (one pair of uprights).

**NOTE:** Always make sure bale spear fully penetrates the bale. Partial penetration locates all the weight of the bale on the outer end and can damage spear.

**NOTE:** In cold weather, a bale frozen to the ground may exceed the lifting capacity of spear and loader. Damage to spear or loader may occur. Not covered under warranty.



## WARNING

**For multiple spear Model SSB-3000 and SSRB Models, always insert spears into the bale – NEVER under the bale. Failure to insert spears into bale can allow bale to roll back when loader is raised, causing serious injury or death.**



## WARNING

**NEVER try to handle two rectangular bales at once without the 831095 optional bolt-on uprights installed. Failure to use the uprights can allow the top bale to roll back when loader is raised, causing serious injury or death.**

# INSTRUCTIONS (continued)

## OPERATION (continued)

### HANDLING ALL BALES:



## DANGER

Beware of low electrical wires when loader is raised. Serious injury or death can result if contact is made.

When stacking bales, ALWAYS MAKE SURE BALES ARE PLACED SO THE STACK IS STABLE.

Keep all bystanders at a safe distance. REMEMBER – FALLING BALES CAN ROLL OR TUMBLE.



## CAUTION

Beware of lift clearance when raising loader to maximum height.

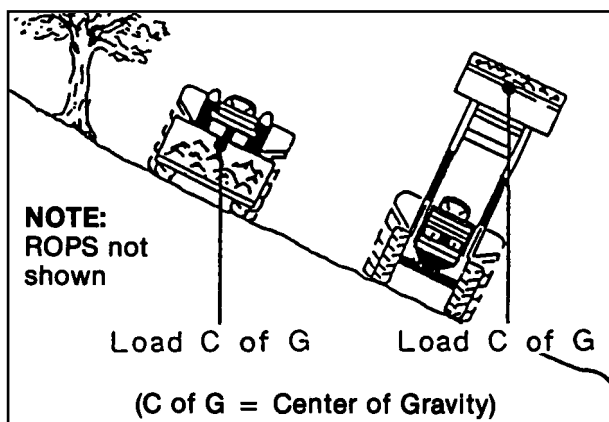

When working on side hills, **DO NOT RAISE LOADER TOO HIGH.** Keep an eye on terrain changes. Keep load low.

## MAINTENANCE

Periodically check all bolts to make sure they are tight.

Check the cross bolt on the forged spears to make sure they are tight.

Lubricate loader as per instructions in loader manual.

Replace safety signs and instruction decals if damaged or missing.

## HANDLE BALES SAFELY

Improper use of loaders to handle bales can result in serious injury or death to the skid steer operator. This could be caused by the bale tumbling back down the loader into the operator's station.

For optimum stability and visibility:

- Do not handle bales that exceed the bale weight limitations of the skid steer or tractor/loader.
- Carry the bale slowly and as low as possible to the ground.
- Operate the loader hydraulic controls smoothly, avoiding jerky operation.
- When handling round bales on a slope, always approach the bale with the power unit facing uphill.
- Never use the skid steer or tractor/loader to stop a rolling bale.
- Only use a tractor or power unit equipped with a ROPS cab or roll-over protective structure.
- Use particular care when working on inclines and hill-sides.
- Avoid holes, ditches, and obstructions which may cause skid steer loader to tip.
- Never allow anyone to walk or work under a raised loader.
- Be sure that people, livestock, or pets are not standing near the machine while operating.
- Lower bucket or attachment to ground when loader is unattended.

## STORING SAFELY

- Always store attachment in a clean, dry location away from children and livestock.
- Storage location should be level and solid to make hitching and unhitching easy.



# SSB-2200 PARTS LIST

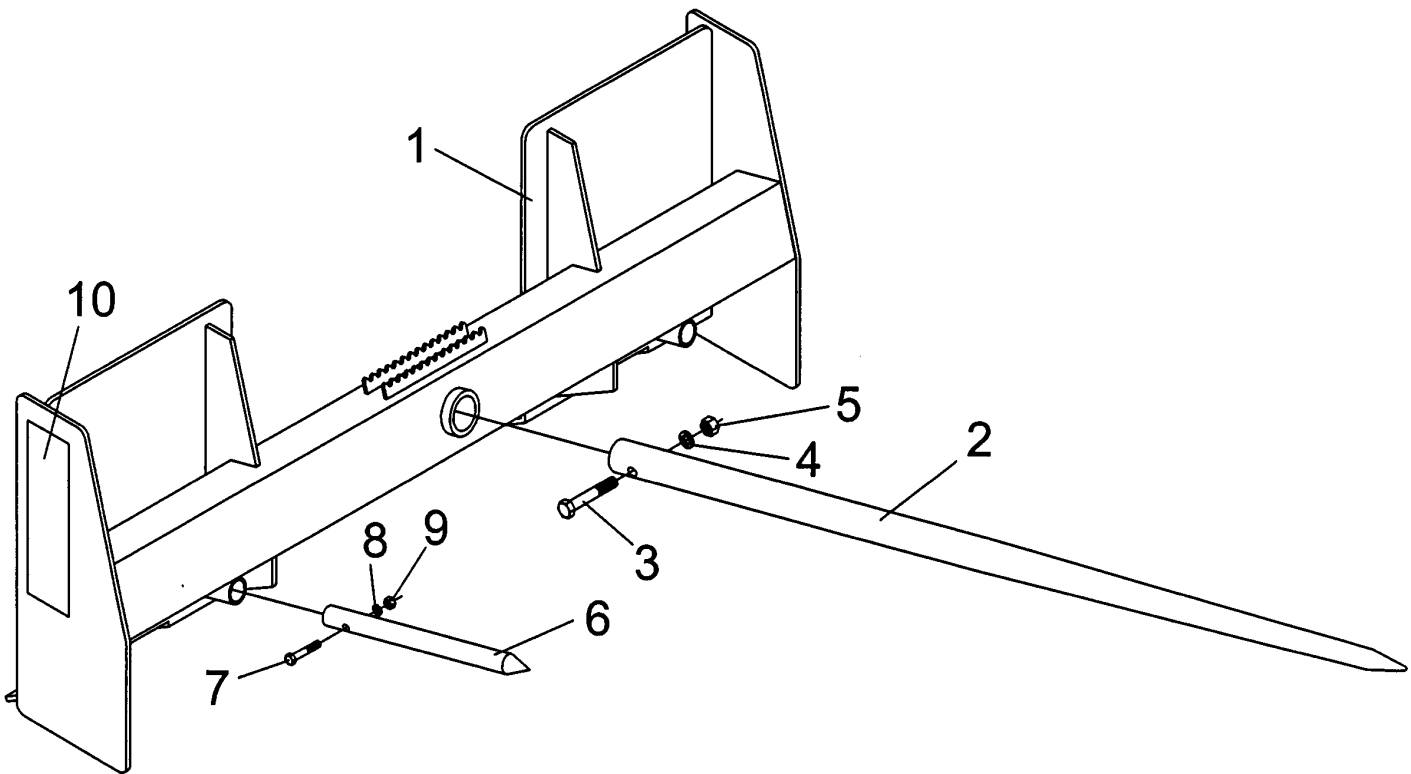

Ref. No.	Part No.	Description	No. Req'd.
1	831065	Main Frame Weldment (SSB-2200)	1
2	830928	Spear, Bolt-In (47 1/4")	1
3	2503012	Bolt 1/2"-13NC x 3" Hex Head Gr. 2	1
4	2502002	Washer 1/2" Springlock	1
5	2500003	Nut 1/2"-13NC Full Hex	1
6	830213	Spike, Balance Ø1"	2
7	2503111	Bolt 5/16"-18NC x 1 3/4" Hex Head Gr. 2	2
8	2502011	Washer 5/16" Springlock	2
9	2500011	Nut 5/16"-18NC Full Hex	2
10	101277	Safety Sign - Warning (Read Manual)	1

# SSB-3000 PARTS LIST

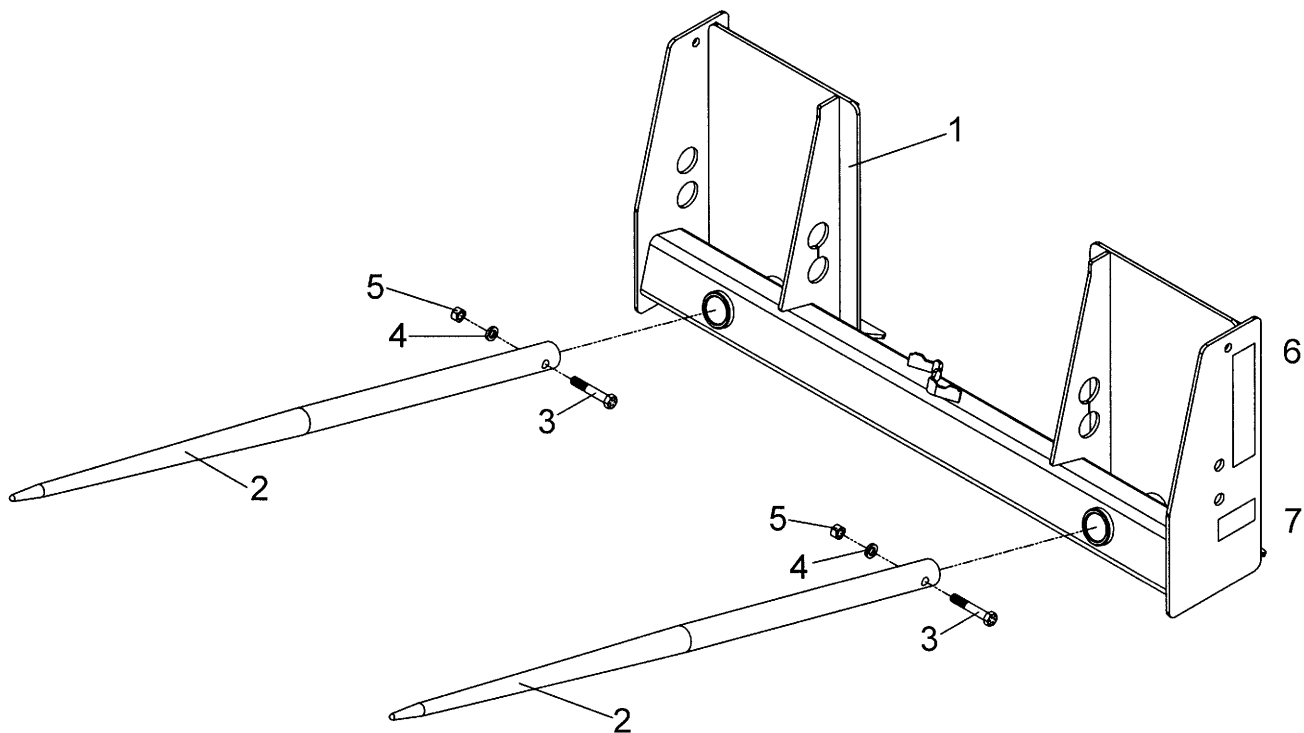

Ref. No.	Part No.	Description	No. Req'd.
1	831075	Main Frame Weldment (SSB-3000)	1
2	830928	Spear, Bolt-In (47 1/4")	2
3	2503012	Bolt 1/2"-13NC x 3" Hex Head Gr. 2	2
4	2502002	Washer 1/2" Springlock	2
5	2500003	Nut 1/2"-13NC Full Hex	2
6	101277	Safety Sign - Warning (Read Manual)	1
7	101127	Safety Sign - Warning (Insert Spears)	1

# SSRB-330/340 PARTS LIST

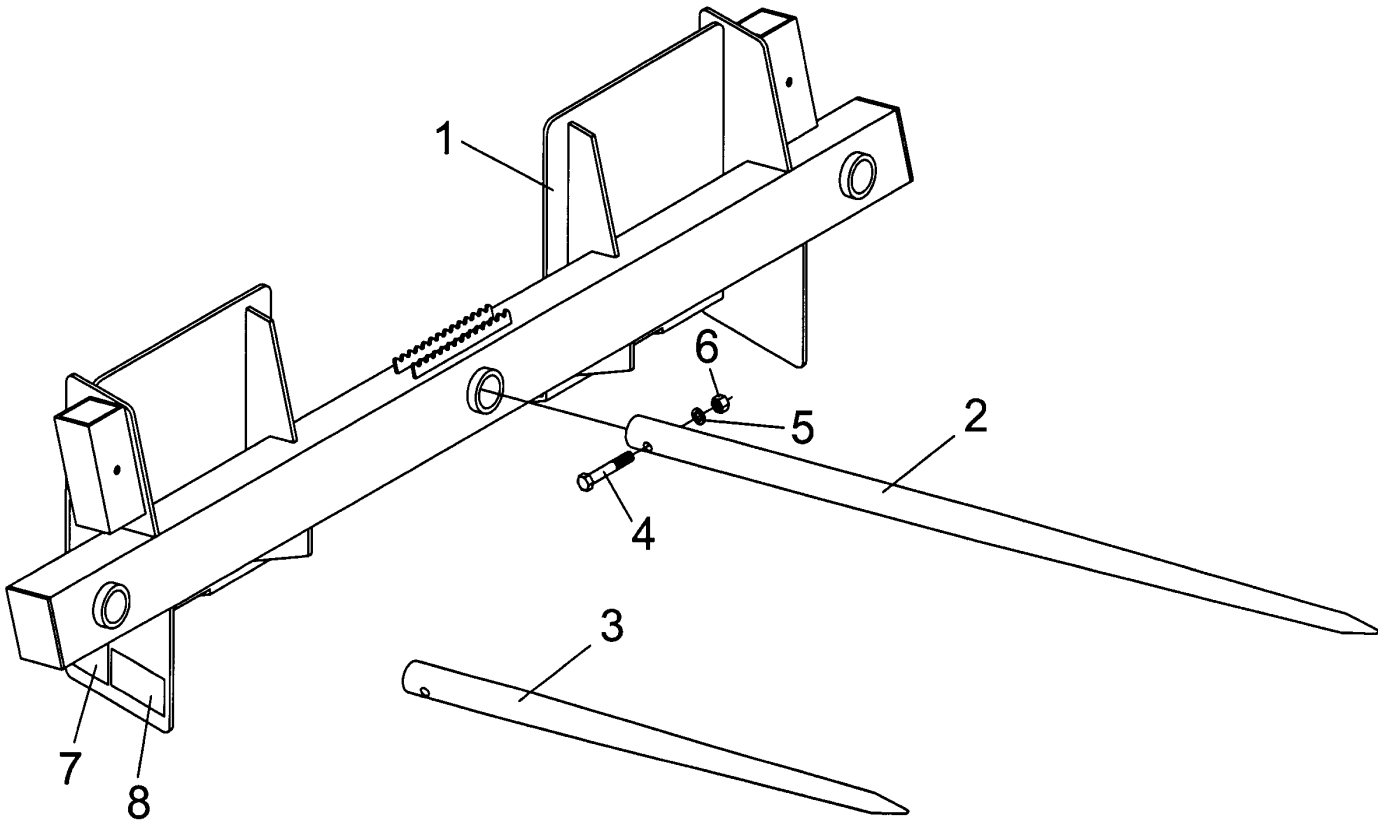

Ref. No.	Part No.	Description	No. Req'd.
1	831085	Main Frame Weldment (SSRB-330/340)	1
2	830928	Spear, Bolt-In 47 1/4" (SSRB-340)	3
3	830924	Spear, Bolt-In 31 1/2" (SSRB-330)	3
4	2503012	Bolt 1/2"-13NC x 3" Hex Head Gr. 2	3
5	2502002	Washer 1/2" Springlock	3
6	2500003	Nut 1/2"-13NC Full Hex	3
7	101277	Safety Sign - Warning (Read Manual)	1
8	101127	Safety Sign - Warning (Insert Spears)	1

# OPTIONAL UPRIGHT KIT PARTS LIST

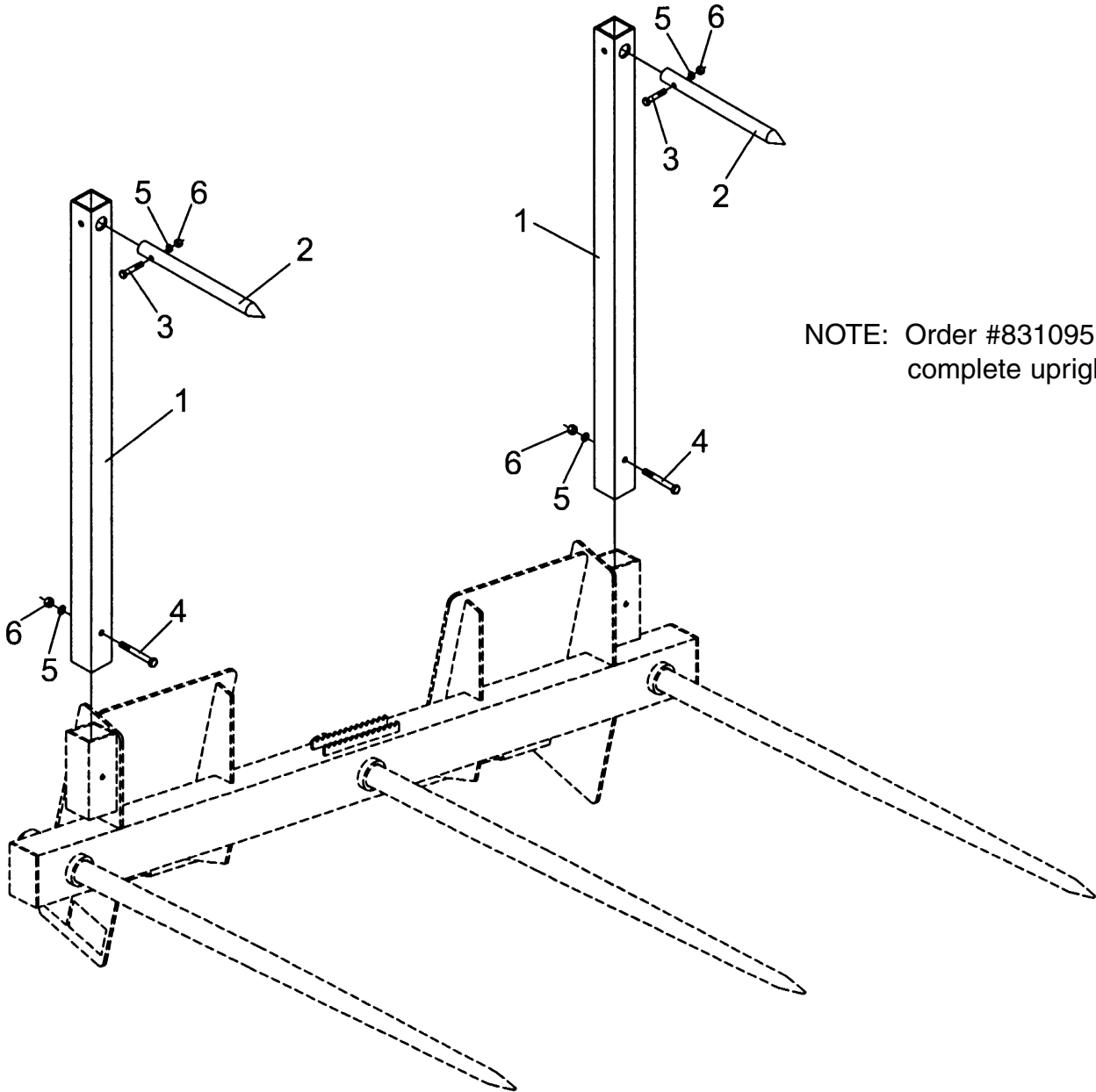

NOTE: Order #831095 for complete upright kit.

Ref. No.	Part No.	Description	No. Req'd.
	831095	Optional Upright Kit Complete	1
1	832285	Tube, Vertical Backstop	2
2	830213	Spike, Balance Ø1"	2
3	2503039	Bolt 3/8"-16NC x 2 1/2" Hex Head Gr. 2	2
4	2503209	Bolt 3/8"-16NC x 3" Hex Head Gr. 2	2
5	2502008	Washer 3/8" Springlock	4
6	2500004	Nut 3/8"-16NC Full Hex	4



# SAFETY REQUIREMENTS

AVOID ACCIDENTS BY FOLLOWING ALL OF THE SAFETY REQUIREMENTS LISTED BELOW.

- Machinery should be operated only by those who are responsible and are authorized to do so.
- Stop the engine, lower all equipment, lock the brakes, and remove the ignition key before dismounting from the skid steer.
- Never stand between power unit and attachment while skid steer is being connected to the attachment.
- Loose fitting clothing should not be worn, to avoid catching on various parts.
- Detach attachment in area where children normally do not play.
- When performing adjustments or maintenance on an attachment, first lower it to the ground or block it securely at a workable height.
- Only a qualified operator should be permitted on power unit when in operation; no riders allowed.
- Make certain everyone is in the clear before starting tractor or raising or lowering equipment.
- Operate the power unit and attachment only while seated in the driver's seat.
- Reduce speed when transporting mounted attachments to avoid bouncing and momentary loss of steering control.
- A heavy load can cause instability of the power unit. Use extreme care during road travel. Slow down on turns and watch out for bumps. Power unit may need front counterweights to counter-balance the weight of the attachment.
- Reduce speed on hillsides or curves so there is no danger of tipping.
- Avoid driving too close to the edge of ditches or drop offs.
- Do not transport implement on public roads without reflectors and slow moving vehicle emblem in daylight and with approved warning lights at night and other periods of poor visibility.
- Keep work area clear of all debris. Never assume an area is clear. ALWAYS CHECK.
- Check to make certain there are no buried utilities in the work area before starting work.
- Keep alert and watch the front as well as the rear when working with the attachment.

## OWNER'S/ OPERATOR'S MANUAL

## MODEL NO.'s

**SSB-2200**

**SSB-3000**

**SSRB-330**

**SSRB-340**

NOVEMBER 2019

## BALE SPEAR ATTACHMENTS

WHEN ORDERING REPAIR PARTS,  
ALWAYS GIVE THE FOLLOWING INFORMATION:

1. PART NUMBER
2. PART DESCRIPTION
3. MODEL NUMBER
4. NAME OF ITEM

**MAKE EVERY DAY  
A HOLIDAY  
FROM ACCIDENTS!**

## WORKSAVER, INC.

P.O. BOX 100 LITCHFIELD, IL 62056-0100 (217) 324-5973  
WEB: <http://www.worksaver.com> E-MAIL: [sales@worksaver.com](mailto:sales@worksaver.com)